

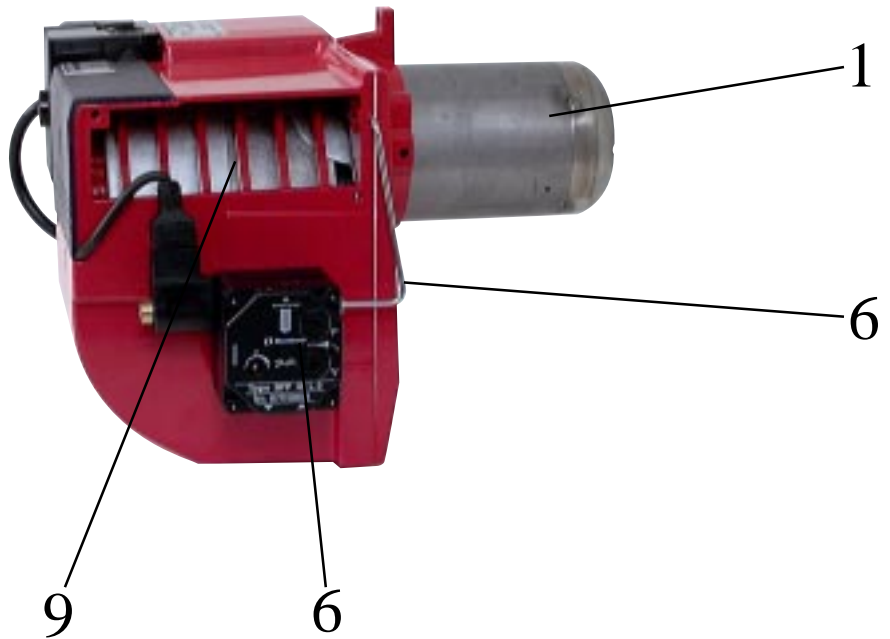

97,108, 120

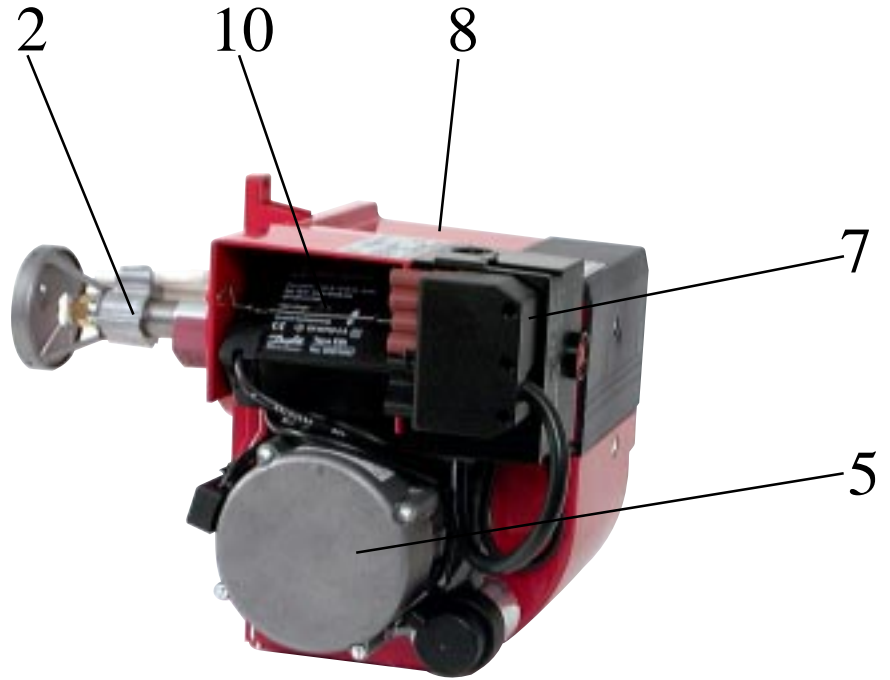

INNEHÅLLSFÖRTECKNING

1. BRÄNNARRÖR	Brännarrör Övrigt	
2. INSATS	Insats Oljerör Bromsskiva	Övrigt
3. ANSLUTNINGSFÄNS	Anslutningsfläns Packning Övrigt	
4. KÅPA	Kåpa Fäste Övrigt	
5. MOTOR	Motor Kondensator Fläkthjul	Koppling Övrigt
6. PUMP	Pump Magnetventil Filter	Förbindelserör Övrigt
7. ELDNINGSAUTOMAT	Eldningsautomat Fotomotstånd Övrigt	
8. FLÄKTHUS	Fläkthus Övrigt	
9. LUFTREGLERING	Luftreglering Övrigt	
10. TRANSFORMATOR	Transformator Övrigt	
11. SLANG	Slang Övrigt	

TABLE OF CONTENTS







1. BURNER TUBE	Burner tube Other articles	
2. NOZZLE ASSEMBLY	Nozzle assembly Nozzle line Shrouded disc	Other articles
3. FIXING FLANGE	Fixing flange Gasket Other articles	
4. COVER	Cover Attachment Other articles	
5. MOTOR	Motor Capacitor Fan wheel	Coupling Other articles
6. PUMP	Pump Solenoid valve Filter	Connecting pipe Other articles
7. OIL BURNER CONTROL	Oil burner control Photoresistor Other articles	
8. FAN HOUSING	Fan housing Other articles	
9. AIR REGULATION	Air regulation Other articles	
10. TRANSFORMER	Transformer Other articles	
11. FLEXIBLE PIPE	Flexible pipe Other articles	

INHALTSVERZEICHNIS

1. BRENNERROHR	Brennerrohr Sonstiges	
2. DÜSENSTOCK	Düsenstock Düsenrohr Stauscheibe	Sonstiges
3. BEFESTIGUNGS- FLANSCH	Anschlussflansch Dichtung Sonstiges	
4. ABDECKHAUBE	Abdeckhaube Befestigung Sonstiges	
5. MOTOR	Motor Kondensator Gebläserad	Kupplung Sonstiges
6. PUMPE	Pumpe Magnetventil Filter	Öldruckrohr Sonstiges
7. FEUERUNGSAUTOMAT	Feuerungsautomat Fotowiderstand Sonstiges	
8. BRENNERGEHÄUSE	Brennergehäuse Sonstiges	
9. LUFTEINSTELLUNG	LuftEinstellung Sonstiges	
10. TRANSFORMATOR	Transformator Sonstiges	
11. NIPPEL	Ölschlauch Sonstiges	

TABLE DES MATIERES

1. TUBE DIFFUSEUR	Tube diffuseur D'autres articles	
2. LIGNE PORTE- GICLEUR	Ligne porte-gicleur Canne porte-gicleur Disque accroche-flamme	D'autres articles
3. BRIDE DE FIXATION	Bride de fixation Joint D'autres articles	
4. CAPOT	Capot Fixation D'autres articles	
5. MOTEUR	Moteur Condensateur Rotor	Manchon D'autres articles
6. POMPE	Pompe Electrovanne Filtre	Trompette D'autres articles
7. COFFRET DE SECURITE	Coffret de sécurité Cellule photorésistante D'autres articles	
8. CARTER DU ROTOR	Carter du rotor D'autres articles	
9. REGLAGE D'AIR	Réglage d'air D'autres articles	
10. TRANSFORMATEUR	Transformateur D'autres articles	
11. FLEXIBLE	Flexible D'autres articles	

	Brännarrör PL 80 mm 10-4-24-10 10-5-24-10 10-5-16-8 10-8-10-6-19-10 127 mm 10-8-10-6-19-10	Blast tube PL 80 mm 10-4-24-10 10-5-24-10 10-5-16-8 10-8-10-6-19-10 127 mm 10-8-10-6-19-10	Brennerrohr PL 80 mm 10-4-24-10 10-5-24-10 10-5-16-8 10-8-10-6-19-10 127 mm 10-8-10-6-19-10	Tube diffuseur PL 80 mm 10-4-24-10 10-5-24-10 10-5-16-8 10-8-10-6-19-10 127 mm 10-8-10-6-19-10	117 802 01 117 803 01 117 803 05 117 804 01 117 804 02			
		Brännarrör PL 80 mm 6-7-21,5-10 6-7-19-10 127 mm 6-7-19-10 157 mm 6-7-19-8 6-7-16-8	Blast tube PL 80 mm 6-7-21,5-10 6-7-19-10 127 mm 6-7-19-10 157 mm 6-7-19-8 6-7-16-8	Brennerrohr PL 80 mm 6-7-21,5-10 6-7-19-10 127 mm 6-7-19-10 157 mm 6-7-19-8 6-7-16-8	Tube diffuseur PL 80 mm 6-7-21,5-10 6-7-19-10 127 mm 6-7-19-10 157 mm 6-7-19-8 6-7-16-8	117 801 03 117 801 05 117 801 06 117 801 11 117 801 09		
			Brännarrör K, KA 94 mm 147 mm	Blast tube K, KA 94 mm 147mm	Brennerrohr K, KA 94 mm 147 mm	Tube diffuseur K, KA 94 mm 147 mm	117 284 01 117 284 02	
				Brännarrör E 87 mm 124 mm rostfritt 215 mm EM 87 mm	Blast tube E 87 mm 124 mm stainless 215 mm EM 87 mm	Brennerrohr E 87 mm 124 mm russfrei 215 mm EM 87 mm	Tube diffuseur E 87 mm 124 mm inoxydable 215 mm EM 87 mm	115 960 05 115 960 01 117 260 03 115 960 06
					Brännarrör FU 103 mm 133 mm	Blast tube FU 103 mm 133 mm	Brennerrohr FU 103 mm 133 mm	Tube diffuseur FU 103 mm 133 mm
					Brännarrör F, FV 127 mm	Blast tube F, FV 127 mm	Brennerrohr F, FV 127 mm	Tube diffuseur F, FV 127 mm
					Brännarrör C 94 mm	Blast tube C 94 mm	Brennerrohr C 94 mm	Tube diffuseur C 94 mm

97, 108, 120

BRÄNNARRÖR BRENNERROHR

BLAST TUBE TUBE DIFFUSEUR

1



Brännarrör
E 87
värmebeständigt

Blast tube
E 87
heat resistant

Brennerrohr
E 87
hitzbeständig







Tube diffuseur
E 87
résistant à la
chaleur







119 340 04

97, 108, 120

INSATS DÜSENSTOCK

NOZZLE ASSEMBLY LIGNE PORTE-GICLEUR 2

	Insats För brännarrör PL 80 mm 127 mm	Nozzle assembly For burner tube PL 80 mm 127 mm	Düsenstock Für Brennerrohr PL 80 mm 127 mm	Ligne porte-gicleur Pour tube diffuseur PL 80 mm 127 mm	118 616 01 118 616 02
	Insats För brännarrör E 87 mm 124 mm 212 mm	Nozzle assembly For burner tube E 87 mm 124 mm 212 mm	Düsenstock Für Brennerrohr E 87 mm 124 mm 212 mm	Ligne porte-gicleur Pour tube diffuseur E 87 mm 124 mm 212 mm	118 616 01 118 616 02 118 616 04
	Insats För brännarrör EM 87 mm	Nozzle assembly For burner tube EM 87 mm	Düsenstock Für Brennerrohr EM 87 mm	Ligne porte-gicleur Pour tube diffuseur EM 87 mm	118 616 01
	Insats För brännarrör KA, C 94 mm 147 mm	Nozzle assembly For burner tube KA, C 94 mm 147 mm	Düsenstock Für Brennerrohr KA, C 94 mm 147 mm	Ligne porte-gicleur Pour tube diffuseur KA, C 94 mm 147 mm	118 945 01 118 945 02
	Insats För brännarrör FUV 103 mm 133 mm	Nozzle assembly For burner tube FUV 103 mm 133 mm	Düsenstock Für Brennerrohr FUV 103 mm 133 mm	Ligne porte-gicleur Pour tube diffuseur FUV 103 mm 133 mm	118 943 01 118 943 02
	Insats För brännarrör PLV 127 mm ST97-108 127 mm Danfoss förvärmare ST 120	Nozzle assembly For burner tube PLV 127 mm ST97-108 127 mm Danfoss preheater ST 120	Düsenstock Für Brennerrohr PLV 127 mm ST97-108 127 mm Danfoss Vorwärmer ST 120	Ligne porte-gicleur Pour tube diffuseur PLV 127 mm ST97-108 127 mm Danfoss réchauffeur ST 120	118 944 02 118 946 02
	Insats För brännarrör FU 103 mm ST 108	Nozzle assembly For burner tube FU 103 mm ST 108	Düsenstock Für Brennerrohr FU 103 mm ST 108	Ligne porte-gicleur Pour tube diffuseur FU 103 mm ST 108	119 858 01









	Oljerör För brännarrör	Nozzle line For burner tube	Düsenrohr Für Brennerrohr	Canne porte-gicleur Pour tube diffuseur	
	FUV 103 mm 133 mm	FUV 103 mm 133 mm	FUV 103 mm 133 mm	FUV 103 mm 133 mm	119 190 01 119 190 07
	Oljerör För brännarrör	Nozzle line For burner tube	Düsenrohr Für Brennerrohr	Canne porte-gicleur Pour tube diffuseur	
	PLV 127 mm ST 97-108 127 mm ST 120	PLV 127 mm ST 97-108 127 mm ST 120	PLV 127 mm ST 97-108 127 mm ST 120	PLV 127 mm ST 97-108 127 mm ST 120	119 190 01 119 190 03
	Oljerör För brännarrör	Nozzle line For burner tube	Düsenrohr Für Brennerrohr	Canne porte-gicleur Pour tube diffuseur	
	PL 80 mm 127 mm	PL 80 mm 127 mm	PL 80 mm 127 mm	PL 80 mm 127 mm	119 189 01 119 189 02
	Oljerör För brännarrör	Nozzle line For burner tube	Düsenrohr Für Brennerrohr	Canne porte-gicleur Pour tube diffuseur	
	E 87 mm 124 mm 212 mm	E 87 mm 124 mm 212 mm	E 87 mm 124 mm 212 mm	E 87 mm 124 mm 212 mm	119 189 01 119 189 02 119 189 04
	Oljerör För brännarrör	Nozzle line For burner tube	Düsenrohr Für Brennerrohr	Canne porte-gicleur Pour tube diffuseur	
	EM 87 mm	EM 87 mm	EM 87 mm	EM 87 mm	119 189 01
	Oljerör För brännarrör	Nozzle line For burner tube	Düsenrohr Für Brennerrohr	Canne porte-gicleur Pour tube diffuseur	
	K, KA, C 94 mm 147 mm	K, KA, C 94 mm 147 mm	K, KA, C 94 mm 147 mm	K, KA, C 94 mm 147 mm	119 189 07 119 189 05
	Oljerör För brännarrör	Nozzle line For burner tube	Düsenrohr Für Brennerrohr	Canne porte-gicleur Pour tube diffuseur	
	KAV 147 mm	KAV 147 mm	KAV 147 mm	KAV 147 mm	119 190 08

	Fövärmare Danfoss	Preheater Satronic Danfoss	Vorwärmer Danfoss	Réchauffeur Danfoss	114 706 05
	Kabel. fövärmare	Cable, preheater	Kabel, Vorwärmer	Cable,réchauffeur	114 777 02
	Elektrodhållare	Elektrode holder	Elektrodenhalter	Porte-électrode	115 984 01
	Skala, insatsreglering	Scale, nozzle assembly adjustment	Skala, Düsenstock- einstellung	Echelle, ligne porte-gicleur	118 881 01
	Täckplåt, insatsreglering	Coverplate, nozzle assembly adjustment	Deckplatte, Düsenstock- einstellung	Plaque de recouvrement, ligne porte-gicleur	118 530 02
	Täckplåt, insatsreglering	Coverplate, nozzle assembly adjustment	Deckplatte, Düsenstock- einstellung	Plaque de recouvrement, ligne porte-gicleur	118 873 01
	Ställskruv, insats	Adjustment screw, nozzle assembly	Stellschraube, Düsenstock	Vis de réglage, ligne porte-gicleur	118 484 01
	Bussning	Bushing	Buchse	Douille	118 479 01
	Distansrör	Spacing tube	Abstandsrohr	Tube d'écartement	117 416 01
	Bromsskiva FUV	Brake plate FUV	Stauscheibe FUV	Disque accroche- flamme FUV	115 912 02

87, 108, 120

INSATS DÜSENSTOCK

NOZZLE ASSEMBLY LIGNE PORTE-GICLEUR 2

	Bromsskiva	Brake plate	Stauscheibe	Disque accroche-flamme	115 915 01
	Tändeledrod, par	Ignition electrode, pair of	Zündeledtrode, paar	Electrode d'allumage, 1 paire	115 937 01
	O-ring, förvärmare	O-ring, preheater	O-ring, Vorwärmer	Joint torique, réchauffeur	113 168 02
	Låsring, förvärmare	Locking ring, preheater	Sicherungsring, Vorwärmer	Circlip, réchauffeur	118 018 02
	Bromsskiva KA, KAV	Brake plate KA, KAV	Stauscheibe KA, KAV	Disque accroche-flamme KA, KAV	118 858 01
	Insats förbrännarrör FV 127 mm	Nozzle assembly For burner tube FV 127 mm	Düsenstock fürbrennerrohr FV 127 mm	Ligne porte-gicleur Pour tube diffuseur FV 127 mm	118 943 01
	Insats förbrännarrör KAV 147 mm	Nozzle assembly For burner tube KAV 147 mm	Düsenstock fürbrennerrohr KAV 147 mm	Ligne porte-gicleur Pour tube diffuseur KAV 147 mm	119 075 05
	Dubbelelektrod	Double electrode	Doppelelektrode	Electrode double	118 867 01
	Oljerör Förbrännarrör FU 103 mm ST 108	Nozzle line For burner tube FU 103 mm ST 108	Düsenrohr Für Brennerrohr FU 103 mm ST 108	Canne porte-gicleur Pour tube diffuseur FU 103 mm ST 108	119 189 02

	Anslutningsfläns	Fixing flange	Anschlussflansch	Bride de fixation	118 525 01
	Anslutningsfläns	Fixing flange	Anschlussflansch	Bride de fixation	118 116 01
	Anslutningsfläns	Fixing flange	Anschlussflansch	Bride de fixation	04 390 308 34
	Packning	Gasket	Dichtung	Joint	118 542 01
	Packning	Gasket	Dichtung	Joint	118 191 01
	Packning	Gasket	Dichtung	Joint	04 390 120 27
	Packning	Gasket	Dichtung	Joint	118 543 01
	Anslutningsfläns	Fixing flange	Anschlussflansch	Bride de fixation	118 830 01
	Packning	Gasket	Dichtung	Joint	118 831 01
	Packning	Gasket	Dichtung	Joint	118 756 03

97, 108, 120

**ANSLUTNINGSFLÄNS
ANSCHLUSSFLANSCH**

**FIXING FLANGE
BRIDE DE FIXATION**

3

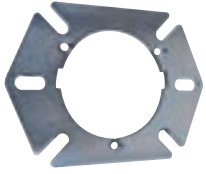

Anslutningsfläns

Fixingflange

Anschlussflansch

Bride de fixation

118 545 01

97, 108, 120

KÅPA
HAUBE

COVER
CAPOT

4



Täcklock

Coverplate

Deckplatte

Plaque
de recouvrement

118 500 01



Skruv











Screw





Schraube

Vis

117 507 02



	Motor 90W, 4mF 4mF Svart 3mF	Motor 90W 4mF 4mF Black 3mF	Motor 90W 4mF 4mF Schwarz 3mF	Moteur 90W 4mF 4mF Noir 3mF	918 483 02 918 483 03 918 483 04
	Fläkthjul 120 x 42 x 8 ST 120	Fan wheel 120 x 42 x 8 ST 120	Gebläserad 120 x 42 x 8 ST 120	Rotor 120 x 42 x 8 ST 120	114 176 01
	97 x 42 x 8 ST 97	97 x 42 x 8 ST 97	97 x 42 x 8 ST 97	97 x 42 x 8 ST 97	114 176 03
	108 x 42 x 8 ST 108	108 x 42 x 8 ST 108	108 x 42 x 8 ST 108	108 x 42 x 8 ST 108	114 176 04
	Drivkoppling	Drive coupling	Antriebskuppling	Accouplement d'entraînement	114 072 10
	O-ring 121,0 x 1,6	O-ring 121,0 x 1,6	O-Ring 121,0 x 1,6	Joint torique 121,0 x 1,6	113 168 41
	Kondensator 3mF 4mF	Capacitor 3mF 4mF	Kondensator 3mF 4mF	Condensateur 3mF 4mF	115 965 04 115 965 01
	Kabel	Cable	Kabel	Câble	117 034 04

	Pump BFP 11L3 Med kabel	Pump BFP 11L3 With cable	Pumpe BFP 11L3 Mit Kabel	Pompe BFP 11L3 Avec câble	117 586 02 917 586 02
	Pump AS47C Med kabel	Pump AS47C With cable	Pumpe AS47C Mit Kabel	Pompe AS47C Avec câble	113 675 32 913 675 32
	Förbindelserör ST 120	Connecting pipe ST 120	Öldruckrohr ST 120	Trompette ST 120	118 551 01
	Förbindelserör PL 80 mm PL 127, 157 mm ST 97/108	Connecting pipe PL 80 mm PL 127, 157 mm ST 97/108	Öldruckrohr PL 80 mm PL 127, 157 mm ST 97/108	Trompette PL 80 mm PL 127, 157 mm ST 97/108	118 638 01 118 845 01
	Nippel, manometer	Nipple, pressure gauge	Nippel, Manometer	Raccord, manomètre	118 607 01
	Förbindelserör FUV, PLV 127mm	Connecting pipe FUV, PLV 127 mm	Öldruckrohr FUV, PLV 127 mm	Trompette FUV, PLV 127mm	118 695 02
	Kabel 400 mm BFP 11L3 AS47C	Cable 400 mm BFP 11L3 AS47C	Kabel 400 mm BFP 11L3 AS47C	Câble 400 mm BFP 11L3 AS47C	115 976 05
	Förbindelserör E 215 mm K 147 mm ST 120	Connecting pipe E 215 mm K 147 mm ST 120	Öldruckrohr E 215 mm K 147 mm ST 120	Trompette E 215 mm K 147 mm ST 120	118 819 01 118 819 02
	Magnetventil BFP Innerdel	Solenoid valve BFP Innerpart	Magnetventil BFP Einsatz	Electrovanne BFP Partie interieure	115 973 03 117 742 01
	Magnetventil AS47C	Solenoid valve AS47C	Magnetventil AS47C	Electrovanne AS47C	915 972 01

	Spole Suntec Danfoss BFP	Coil Suntec Danfoss BFP	Spule Suntec Danfoss BFP	Bobine Suntec Danfoss BFP	915 971 01 115 974 03
	Pump BFP41L3 Med kabel	Pump BFP41L3 With cable	Pumpe BFP41L3 Mit Kabel	Pompe BFPL3 Avec câble	117 586 01 917 586 01
	Filter BFP41L3	Filter BFP41L3	Filter BFP41L3	Filtre BFP41L3	117 749 01
	Filter AS47C	Filter AS47C	Filter AS47C	Filtre AS47C	114 570 02
	Packning, lock Suntec	Gasket, cover Suntec	Dichtung, Deckel Suntec	Joint, couvercle Suntec	114 566 01

	Reläbox TF 832.3 Industriförpackning Styckförpackning	Control box TF 832.3 Industrial package Single-piece package	Steuergerät Oberteil TF 832.3 Industrie verpackung Stückverpackung TF 834E.3 Industrie verpackung	Boite de contrôle TF 832.3 Emballage industriel Emballage par pièces TF 834E.3 Emballage industriel Emballage par pièces	117 810 07 917 810 07
	TF 834E.3 Industriförpackning Styckförpackning	TF 834E.3 Industrial package Single-piece package	Industrie verpackung Stückverpackung	TF 834E.3 Emballage industriel Emballage par pièces	117 027 04 917 027 04
	Reläbox LOA 24 Industriförpackning Styckförpackning	Control box LOA 24 Industrial package Single-piece package	Steuergerät Oberteil LOA 24 Industrie verpackung Stückverpackung	Boite de contrôle LOA 24 Emballage industriel Emballage par pièces	115 595 07 915 595 07
	Reläsockel Satronic kpl. för kallstart	Relay base Satronic compl. for cold start	Steuergerät Unterteil Satronic kompl. für Kaltstart	Socle de raccordement Satronic pour démarrage à froid	118 012 04
	Reläsockel Landis & Stefa kpl.	Relay base Landis & Stefa compl.	Steuergerät Unterteil Landis & Stefa kompl.	Socle de raccordement Landis & Stefa compl.	915 596 00
	Reläsockel Satronic kpl.	Relay base Satronic compl.	Steuergerät Unterteil Satronic kompl.	Socle de raccordement Satronic compl.	90 390 109 01
	Fläns, fotomotstånd Satronic	Flange, photoresistor Satronic	Flansch, Fotowiderstand Satronic	Bride, cellule photorésistante Satronic	390 113 03
	Fläns, fotomotstånd Landis & Stefa	Flange, photoresistor Landis & Stefa	Flansch, Fotowiderstand Landis & Stefa	Bride, cellule photorésistante Landis & Stefa	117 768 01
	Fotomotstånd Satronic MZ 770S långt utförande kort utförande	Photoresistor Satronic MZ 770S long design short design	Fotowiderstand Satronic MZ 770S lange Ausführung kurze Ausführung	Cellule photorésistante Satronic MZ 770S longue courte	118 003 01 118 003 03

	Packning, fotomotstånd	Gasket, photoresistor	Dichtung, Fotowiderstand	Joint, cellule photorésistante	118 560 01
	Kontaktbon, hondel 7-pol	Plug-in contact, female 7-pole	Buchsenteil 7-polig	Prise "européenne", femelle 7-polaire	115 586 04
	Kontaktbon, handel 7-pol	Plug-in contact, male 7-pole	Steckerteil 7-polig	Prise "européenne", mâle 7-polaire	115 585 00
	Kabelgenomföring	Cable inlet	Kabeldurchführung	Douille de passage câble	118 100 01
	Kabel MZ770	Cable MZ770	Kabel MZ770	Câble MZ770	118 561 01
	Fotomotstånd Landis & Stefa QRB1-A kpl.	Photoresistor Landis & Stefa QRB1-A compl.	Fotowiderstand Landis & Stefa QRB1-A compl.	Cellule photorésistante, Landis & Stefa QRB1-A compl.	912 409 05 912 409 07
	kort utförande långt utförande	short design long design	kurze Ausführung lange Ausführung	courte longue	
	Fotomotstånd Satronic MZ770	Photoresistor Satronic MZ770	Fotowiderstand Satronic MZ770	Cellule photorésistante Satronic MZ770	04 390 295 67

	Fläkthusdel, bakre röd omålad	Fan housing, rear part red non-lacquered	Brennergehäuse, hinterer Teil rot nicht lackiert	Carter du rotor, partie arrière rouge non-lacqué	118 497 0227 118 497 02
	Fläkthusdel, främre röd omålad KA ST 120	Fan housing, front part red non-lacquered KA ST 120	Brennergehäuse, vorderer Teil rot nicht lackiert KA ST 120	Carter du rotor, partie frontale rouge non-lacqué KA ST 120	118 495 0227 118 495 02 118 884 0227
	Fläkthusdel, främre röd omålad ST 97/108	Fan housing, front part red non-lacquered ST 97/108	Brennergehäuse, vorderer Teil rot nicht lackiert ST 97/108	Carter du rotor, partie frontale rouge non-lacqué ST 97/108	118 569 0227 118 569 02
	Avskärmningsvägg, fläkthus ST 120 ST 97/108	Shielding arrangement, fan housing ST 120 ST 97/108	Abschirmung, Brennergehäuse ST 120 ST 97/108	Ecran de partition, carter du rotor ST 120 ST 97/108	118 496 01 118 608 01
	Packning, fläkthus	Gasket, fan housing	Dichtung, Brennergehäuse	Joint, carter du rotor	118 544 01

	Bussning	Bushing	Buchse	Douille	118 479 01
	Anslutningsstos kpl.	Connecting piece compl.	Anschluss-Stück kompl.	Pièce de raccordement compl.	918 591 04
	Packing, anslutningsstos	Gasket, connecting piece	Dichtung, Anschluss-Stück	Joint, Pièce de raccordement	118 541 01
	Luftregleringsplåt	Air regulation plate	Luftstellplatte	Plaque de réglage d'air	118 522 01
	Luftspjäll	Air damper	Luftklappe	Volet d'air	118 510 01
	Ställskruv, luftreglering	Adjustment screw, air regulation	Stellschraube, LuftEinstellung	Vis de réglage, réglage d'air	118 485 01
	Skala, luftreglering	Scale air regulation	Skala, LuftEinstellung	Echelle, réglage d'air	118 878 01
	Täckplåt, luftreglering	Cover plate, air regulation	Deckplatte, LuftEinstellung	Plaque de recouvrement, réglage d'air	118 870 01
	Ljuddämpare, svart Med ram för självstängande luftspjäll, omålad svart	Silencer, black With frame for automatic air damper, non-lacquered black	Schalldämpfer, schwarz Mit Rahmen für Luftansaug- vorrichtung, nicht lackiert schwarz	Silencieux, noir Avec cadre pour clapet d'air automatique, non-lacqué noir	118 749 0105 918 838 01 918 838 02



Anslutningstos
kompl.
svart

Connection piece
compl.
black

Anschluss-Stück
kompl.
schwarz

Piece de
raccordement
compl.
noir

918 591 07

	Transformator Danfoss EBI Kabel med clips	Transformer Danfoss EBI Cable with clips	Transformator Danfoss EBI Kabel mit Klammern	Transformateur Danfoss EBI Câble avec crampons	115 977 01 117 570 12
	Transformator Danfoss EBI	Transformer Danfoss EBI	Transformator Danfoss EBI	Transformateur Danfoss EBI	915 977 01
	Kabelgenomföring	Cable inlet	Kabeldurch- führung	Douille de Câble H.T.	118 546 01
	Fästfjäder, transformator	Fixing spring, transformer	Befestigungs- feder, Transformator	Ressort de fixation, transformateur	118 558 01
	Tändkabelpar	Pair of ignition cable	Zündkabelpaar	Câble H.T. 1 paire	118 559 01
	Kabel med clips transformator	Cable with clips transformer	Kabel mit Klammern, Transformator	Câble avec crampons, transformateur	117 570 12
	Kabel transformator	Cable, transformer	Kabel Transformator	Câble transformateur	117 570 02



Oljeslang,
vinkel

Flexible pipe with
angle nipple

Ölschlauch mit
Winkelnippel

Flexible avec
raccord coudé

1/4"x500x1/4"

1/4"x500x1/4"

1/4"x500x1/4"

1/4"x500x1/4"

117 808 01

1/4"x1000x1/4"

1/4"x1000x1/4"

1/4"x1000x1/4"

1/4"x1000x1/4"

115 545 13

1/4"x700x1/4"

1/4"x700x1/4"

1/4"x700x1/4"

1/4"x700x1/4"

117 808 02

1/4"x700x1/4"

1/4"x700x1/4"

1/4"x700x1/4"

1/4"x700x1/4"

117 807 02