

## Oil Burner Safety Control

**For 1- or 2-stage oil power burners up to 30kg/h capacity and intermittent operations.**

### Flame detection:

- Photoresistor MZ 770 S
- Infrared-flicker detector IRD 1010
- UV solid state sensor UVD 970

### APPLICATION RANGE

The TF 830.3 or TF 832.3 oil burner safety control boxes are suitable to control and monitor oil power burner up to 30 kg/h capacity (approved and certified according to EN230).

### TYPES AVAILABLE

TF 830.3	1-stage operation post-ignition time ca. 20 sec. low voltage protection according to EN230
TF 832.3	2-stage operation post-ignition time 2-5 sec. low voltage protection according to EN230

### CONSTRUCTIONAL FEATURES

The control box circuitry is protected by a flame resistant, transparent plastic housing. It incorporates the thermo-mechanical, temperature compensated timer, flame check and reset circuits.

Manual reset from lockout is provided by a push button with an integrated lockout signal lamp. A central fixing screw locks the control box to the wiring base. The wiring base and control box have a positive plug-in arrangement, making it impossible to achieve an incorrect connection between the two parts. A variety of cable entry points provides utmost flexibility of electrical wiring.

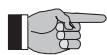

The TF 832.3 is fully compatible with the TF 730, 730-1 and TF 832. The flame detector IRD 911 must be replaced by its compatible type IRD 1010. An optional extension button (item no. 70601) compensates for height differences.



### TECHNICAL DATA

Operating voltage	220/240 V (-15...+10%) 50 Hz (40-60Hz)
Fuse rating	10 A fast, 6 A slow
Power consumption	ca. 5 VA
Max. load per output	
- terminal 3	1.5 A, cos φ 0.2
- terminal 4	4.0 A, cos φ 0.4
- terminal 5	0.5 A, cos φ 0.4
- terminal 6	0.5 A, cos φ 0.4
- terminal 7	0.1 A, cos φ 0.4
total load	5.0 A, cos φ 0.4
Pre-purge time	ca. 12 sec.
Pre-ignition time	ca. 12 sec.
Post-ignition time	TF 830.3 ca. 20 sec. TF 832.3 ca. 2-5 sec.
Delay time to oil valve 2	40 sec. (TF 832.3)
Lockout safety time	10 sec.
Reset time from lockout	ca. 90 sec.
Flame detector:	
MZ 770 S	side-on and end-on viewing
Light sensitivity MZ 770 S	> 6 Lux
IRD 1010	side-on or end-on viewing
UVD 970	end-on viewing
Sensor operating current	min. 30 μA
Weight incl. wiring base	0.25 kg
Mounting position	any
Protection class	IP44
Recommended ambient operating temperature for control and flame detector	0°C...+60°C
approved and certified according to European standards	EN 230

## APPLICATION NOTES

### 1. Flame control

The following detectors can be used for flame control:

- For yellow oil flame: photoresistor MZ 770 S
- for blue or yellow flame: infrared-flicker detector type IRD 1010 or as alternative the UV solid state sensor UVD 970.

Using the photo resistor MZ 770 S, the no flame signal is generated at light levels below 3 Lux with respect to the operating cycle of the control. According to EN 230 stray light safety level has to be established in conjunction with the accompanying burner.

Connecting the IRD 1010 or the UVD 970, the correct wiring has to be observed.

### 2. Burner control

For burners without an oil solenoid valve, the burner motor has to be connected to terminal 5.

### 3. Low-voltage protection

The start up of the burner can only take place if the mains voltage is higher than a limit which is 15% below nominal value. If the voltage drops below 160V, a start-up is prevented or – without allowing to release the fuel – the control box goes into lock out mode.

### 4. Safety

The design and control sequence of the TF 830.3 and TF 832.3 control boxes comply with the currently applicable European standards and regulations.

### 6. Mounting and electrical wiring

Wiring base:

- 3 earth terminals with additional terminal for burner earthing
- 3 neutral terminals with internal permanent connection to neutral terminal (terminal 8)
- 2 spare auxiliary terminals
- 2 slide in plates and 2 easy-knockout holes (PG 11 thread), plus 2 easy-knockout holes in the bottom of the base facilitate the wiring.

General:

- The control box can be mounted in any position. The protection class is IP44 (water spray tight). Neither the control box nor the flame detector should be subjected

## COMMISSIONING AND ROUTINE CHECKS

### 1. Important notes

- The controls must be installed by qualified personnel only. The relevant national regulations have to be observed.
- On commissioning the wiring has to be carefully checked according the appropriate diagram, Incorrect wiring can damage the unit and endanger the installation.
- The fuse rating has to ensure that the limits specified in TECHNICAL DATA will not be exceeded. If these precautions are not observed, the effect of a short circuit can cause severe damage to the control and installation.
- For safety reasons a minimum of one control shut-down per 24 hours has to be observed.
- Disconnect the mains before the control box is plugged in or out!
- The control box is a safety device and must not be opened!

### 2. Function control

For safety reasons the flame detection system should be tested on commissioning the installation as well as after a service or longer shut-down.

- a) Start-up with covered flame detector
  - After lock-out safety time is over the unit has to go in to lockout mode!
- b) Start-up with exposed flame detector:
  - After 20 sec. pre-purge time the unit has to go into lockout mode!
- c) Normal start-up with burner in the normal position, cover up the flame detector:
  - After start-up, and end of lock-out safety time the unit has to go into lockout mode!

### 3. Fault findings

Burner is not working:

- thermostat circuit open
- faulty electrical wiring
- mains voltage too low

Burner starts, but the flame does not establish, a lock out occurs:

- stray light on flame detector
- no ignition or no fuel
- mains voltage more than -15% below nominal value.

Burner starts, the flame establishes, but after the safety time, a lock out occurs:

- dirty or faulty flame detector
- insufficient light on detector
- sensitivity adjustment too low on IRD.

For a quick and safe diagnosis use the Satronic UP 940 burner test box.

### CIRCUIT AND TIMING DIAGRAM TF 830.3

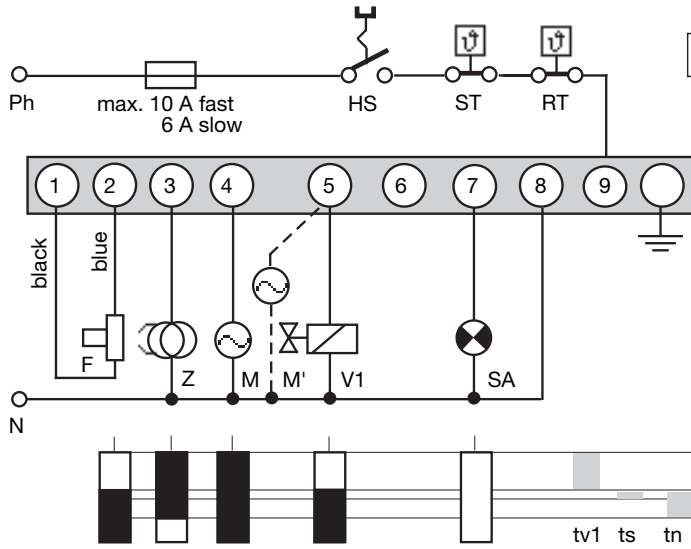

### IRD-OR UVD CONNECTION

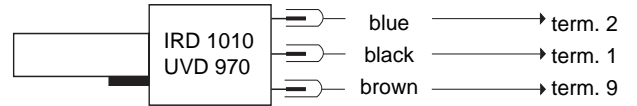

- HS Mains switch
- ST Limit thermostat
- RT Control thermostat
- F Flame detector MZ 770 S (IRD 1010, UVD 970 see separate diagram)
- Z Ignition
- M Burner motor (burner **with** solenoid valve)
- M' Burner motor (burner **without** solenoid valve)
- V1 Oil solenoid valve, 1st-stage
- SA External lock-out signal
- tv1 Pre-ignition time with or without pre-purge
- ts Lock-out safety time
- tn Post-ignition time

### CIRCUIT AND TIMING DIAGRAM 832.3

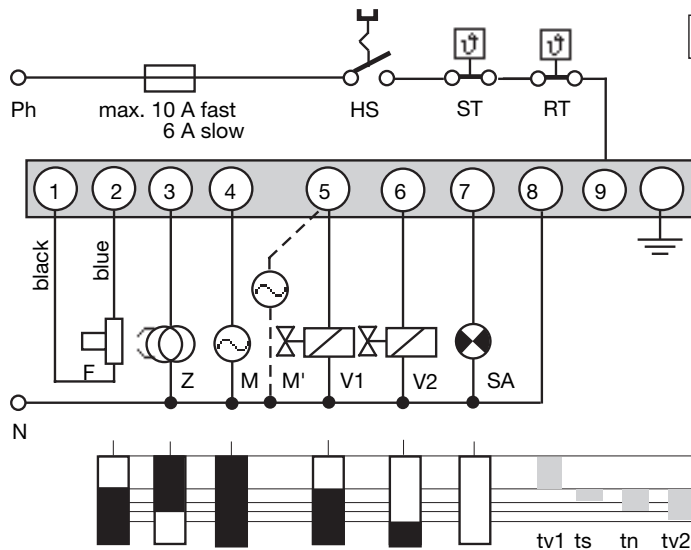

### IRD-OR UVD CONNECTION

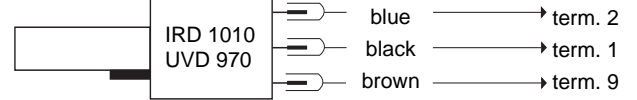

- HS Mains switch
- ST Limit thermostat
- RT Control thermostat
- F Flame detector MZ 770 S (IRD 1010, UVD 970 see separate diagram)
- Z Ignition
- M Burner motor (burner **with** solenoid valve)
- M' Burner motor (burner **without** solenoid valve)
- V1 Oil solenoid valve, 1st-stage
- V2 Oil solenoid valve, 2nd stage
- SA External lock-out signal
- tv1 Pre-ignition time with or without pre-purge
- ts Lock-out safety time
- tn Post-ignition time
- tv2 Delay 2nd stage

### SCHEMATIC DIAGRAM TF 830.3

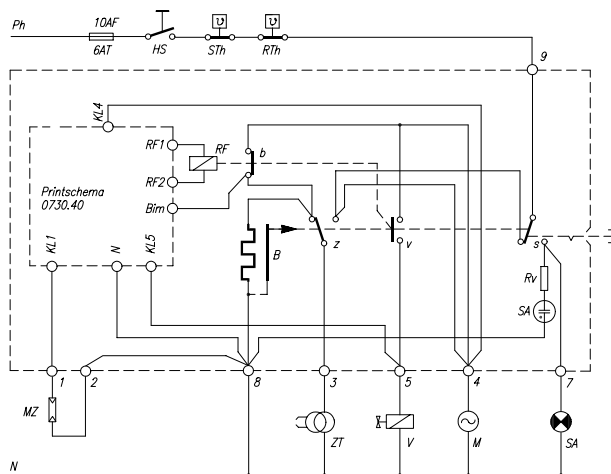

### SCHEMATIC DIAGRAM TF 832.3

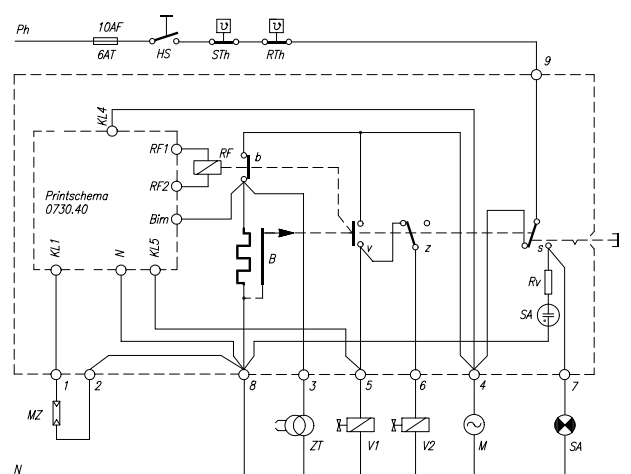

- HS Mains switch
- ST Limit thermostat
- RT Control thermostat
- SA Lock-out signal indicator

- F Flame detector MZ 770 S, IRD 1010 or UVD 970
- V Valves
- Z Ignition
- M Burner motor

- RF Flame relay
- rl low voltage relay
- B Thermomechanical timer
- RV Resistor

### TF 83X AND SOCKET

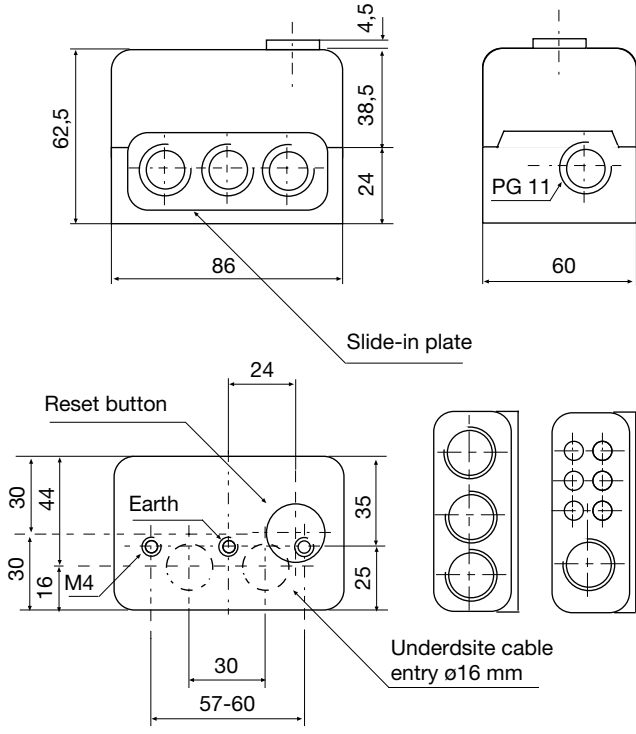

### HOLDER MZ 770 S

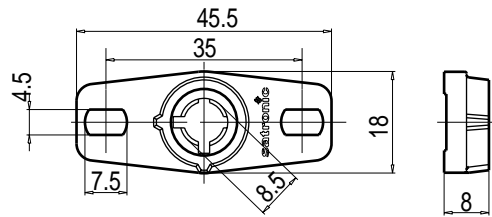

### SHAFT MZ 770 S

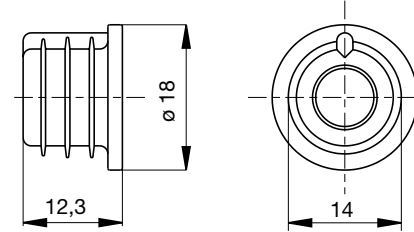

### PHOTORESISTOR MZ 770 S

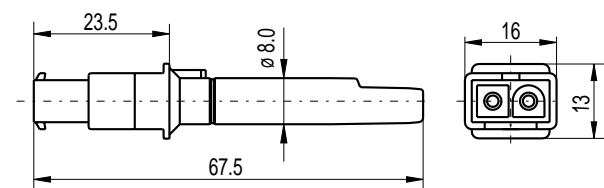

### UVD 970

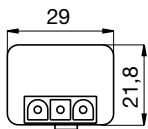

### IRD 1010

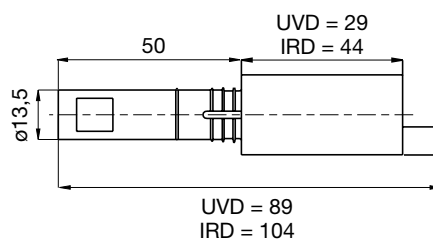
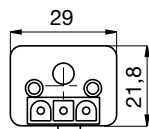

### HOLDER M 74 FOR IRD OR UVD

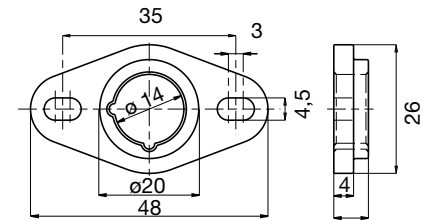

### VARIATION IRD

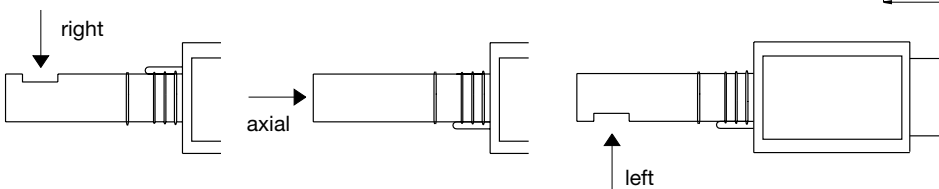

### ORDERING INFORMATION

ITEM	DESIGNATION	ITEM NO.
Control box	Type TF 830.3	02231
Control box	Type TF 832.3	02431
Socket	Socket 701 ABEN	70001
Insert plate	PG-Plate	70502
optional	Cable entry plate	70501
Flame detector	MZ 770 S	50001
optional	MZ 770 S mounted in shaft	51001
optional	IRD 1010 right	16501
optional	IRD 1010 end-on	16502
optional	IRD 1010 left	16503
optional	UVD 970	16702
Support for flame detector	Holder for MZ	59101
optional	Holder M 74 for IRD, UVD	59074
Connectioncable IRD/UVD	Plug type, 3 core cable, 0.6 m, with tag wire ends	7236001
Connectioncable MZ	Plug type, 2 core cable, 0.5 m, with tag wire ends	7225001

The above ordering information refers to the standard version.  
Special versions are also included in our product range.

Specifications subject to change without notice

## TF 830.3 / 832.3

**satronic**

A Honeywell Company

Satronic AG  
Brüelstrasse 7  
Postfach 324  
CH-8157 Dielsdorf