

MGN 2300-LN LMV

Gas

Edition February 2023
Subject to tech. modifications
to improve the product!

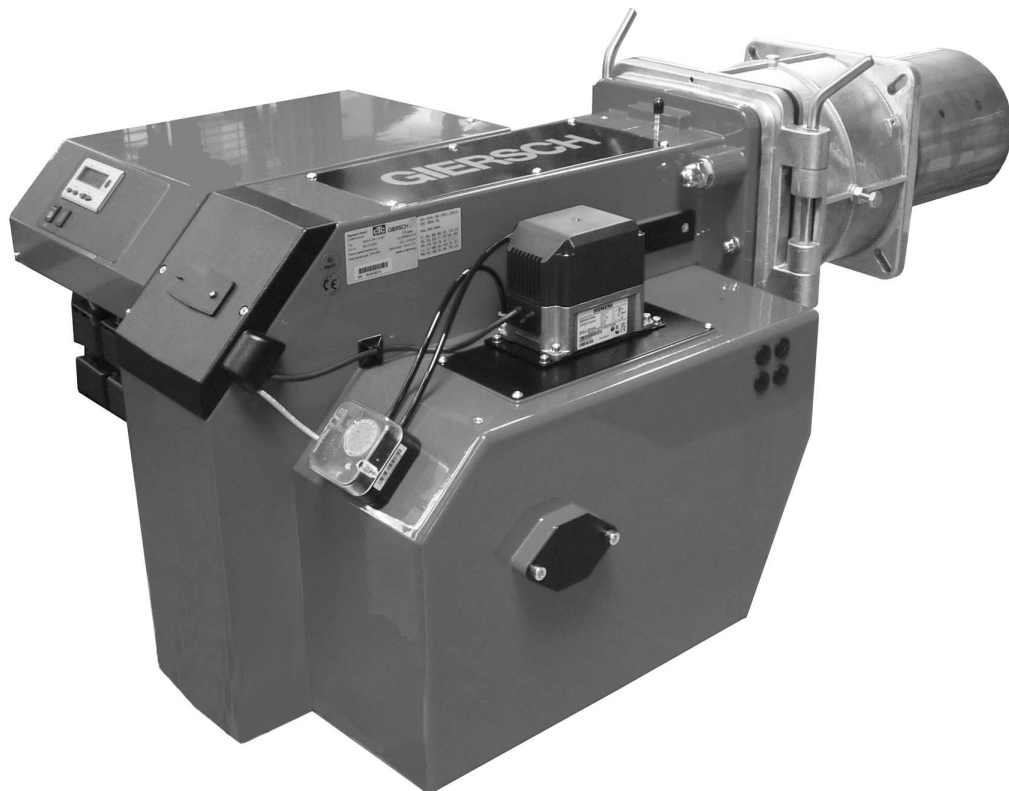

Contents

1	General information	3
2	Checking the scope of delivery and electrical ratings	3
3	Maintenance and customer service	4
4	Operating instructions	4
5	Instruction of operating personnel.....	4
6	Key for code designation	4
7	Technical specifications	5
8	Boiler connection dimensions	5
9	Mounting the gas jacket mantel at the boiler	5
10	Mounting the burner housing on the gas jacket (service position)	6
11	Terminal diagram connector pin assignments	7
12	Electrical connection	8
13	Air flap positioning motor	9
14	Air pressure switch	9
15	Gas pressure monitor	10
16	Adjusting the ignition electrode	11
17	Adjusting the mixing head	11
18	Flame control with ionisation monitor.....	12
19	Connection diagram LMV27	13
20	Operating instructions and equipment description LMV.....	14
21	Start-up and calibration	15
22	Gas burner with gas train KEV _{II} 1 ½", KEV 2", DN65, DN80, DN100.....	21
23	Calculation principles for gas burner adjustment	23
24	Adjustment tables	24
25	Error code list LMV	25
26	Adjustments log	27
27	Exploded view / spare parts list.....	28
28	Overall dimensions	30
29	Working range.....	30

1 General information

Installation of a gas-fired heating system must be performed in accordance with the applicable regulations and guidelines. It is therefore the duty of the installer to be fully familiar with all regulations. Installation, start-up and maintenance must be performed with utmost care.

The burner must not be operated in rooms with high levels of air humidity (laundry rooms), dust or corrosive vapours. The boiler room must be ventilated accordingly with ventilation air.

MG Series gas burners are suitable for combustion of natural gas in accordance with DIN EN 437 and are in compliance with the DIN EN 676 European standard.

2 Checking scope of supply and electrical ratings

Before installing the gas burner, please check the scope of delivery.

Scope of delivery:

burner housing, gas jacket with burner pipe, mounting kit, documentation and gas train.

Gas installation and commissioning are subject to the applicable national regulations, e.g. in Germany the Technical Regulations of the DVGW (DVGW-TR-GI).

The following must be observed for Switzerland: SVGW Gas Provisions G1, G3: Gas installation EKAS Form.

1942: Liquefied gas regulation, Part 2 Regulations of cantonal authorities (e. g. fire department regulations).

The gas pipe must be designed to conform to the flow rate and the available gas flow pressure and routed with the lowest pressure loss over the shortest distance to the burner.

The loss of gas pressure via the gas train and the burner as well as the resistance on the fuel gas side of the heat generator must be less than the connection flow pressure.

Caution !

Observe sequence and through-flow direction of valves and fittings.



3 Maintenance and customer service

The complete system should be checked once a year for proper functioning and leak tightness by an authorised representative of the manufacturer or by another expert.

Only qualified personnel may open only for maintenance, not during on-going operation. Prior to opening/swinging out, de-energise the burner and let it cool down. After completion of work, close the burner again.

Wear protective clothing|/hearing protection when working in the boiler house

We accept no liability for consequential damage in cases of incorrect installation or repair, the fitting of non-genuine parts or where the equipment has been used for purposes for which it was not intended.

4 Operating instructions

The operating instructions together with this technical information leaflet must be displayed in a clearly visible position in the boiler room. The address of the nearest customer service centre must be displayed on the back of the operating instructions.

5 Instruction of operating personnel

Failures are often caused by operator error. The operating personnel must be properly instructed in how the burner works. In the event of recurring faults, Customer Service should be notified.

6 Key for code designation

MGN 2300-ZM- L- N- LN

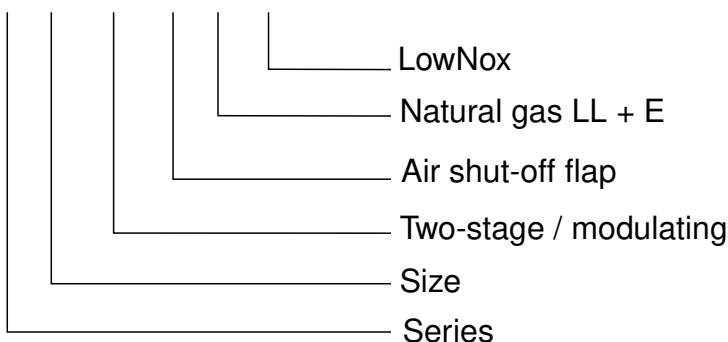

7 Technical specifications

	Burner type
Technical data	MGN2300-LN
Burner output in kW	450 - 2300
Gas type	for natural gas LL + E = "N", LPG = „L“
Method of operating	2-stage sliding / modulating
Voltage	230 / 400 V - 50 Hz
max. current consumption start/operation	16,5 A max./ 11,4 A eff.
Electric motor power (at 2800min ⁻¹) in kW	4,5
Flame failure controller	Ionisation
Control box	LMV27
Weight in kg	120
Noise emission in dB (A)	81
Gas burner class	3
NOx Limit value	≤ 80 mg/kWh

8 Boiler connection dimensions

Dimensions in mm

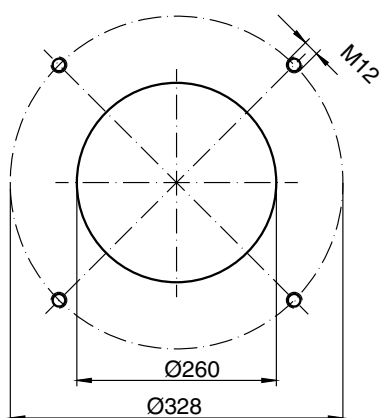

Air pressure connection

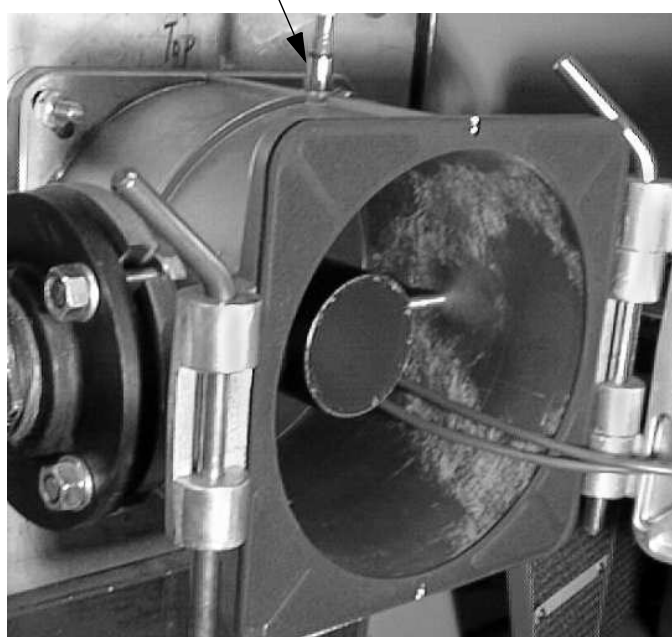

9 Mounting the gas jacket on the boiler

The boiler connection plate must be prepared according to the dimensions specified for the boiler connection dimensions. You can use the gas-jacket gasket as a template.

Screw the gas jacket to the boiler using the four M10 fastening screws with washers and a size Allen key. The air pressure switch for the gas train must be at the top.

10 Mounting the burner housing on the gas jacket (service position)

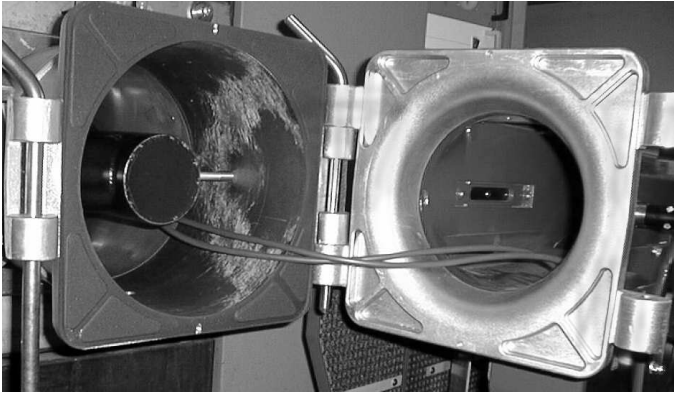

Position the burner housing in the gas-jacket hinge and secure it with a rod. The burner is now in the service position.

Attach the ignition and ionisation cable to the ignition and ionisation electrodes.



**Carefully swing the burner closed.
Do not pinch electrical cables.**

Insert the second mounting rod into the hinge. Tighten the screw at the top to secure the burner in position.

11 Terminal diagram - connector pin assignments



If the male connector has already been wired: check the connections according to the connection diagram!

The electrical connection of the burner must be made in the male connector included according to the connection diagram, taking account of the local regulations.

The supply cable must be fused with max. 10 A fast blow or 6.3 A slow blow and must be routed using flexible cable.

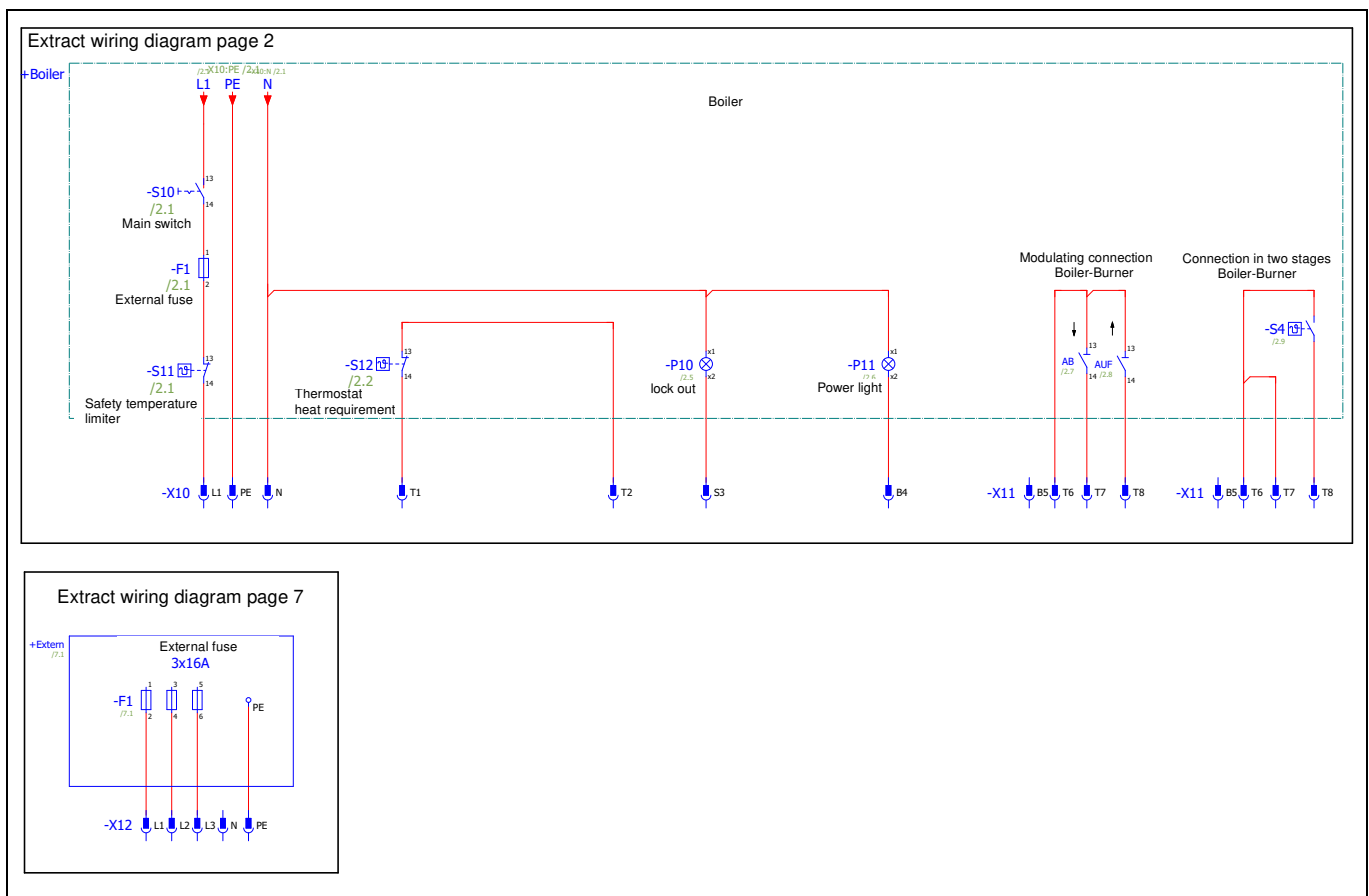

Information,
the following circuit diagram is enclosed separately:
SP_1-1029

12 Electrical connection

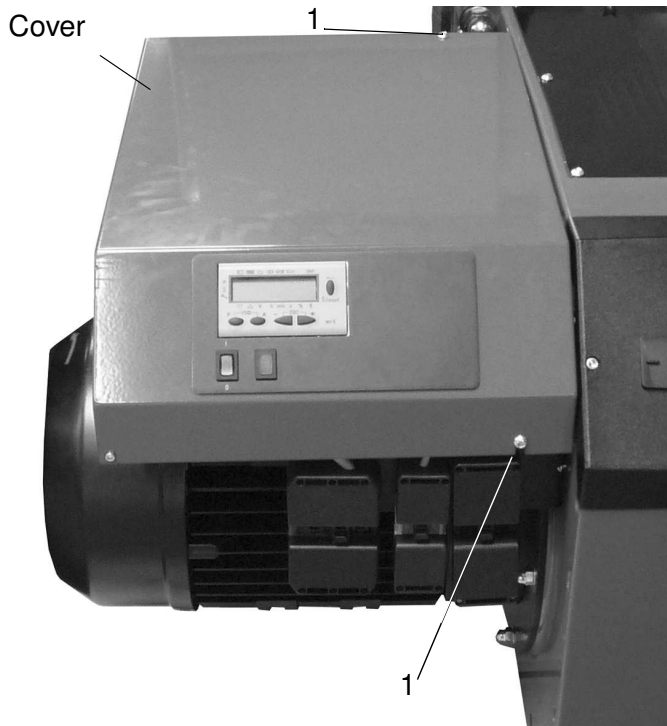

De-energise the burner when carrying out connection work and removing electrical parts!

The burner must be connected to the electricity supply in accordance with the wiring diagram. This work must be performed by trained, qualified electricians. The supply cable to the burner must be of the flexible type.



To access the firing unit, the cover must be brought to the service position. To do this, remove the securing screws (1) and fold the cover down to the left.

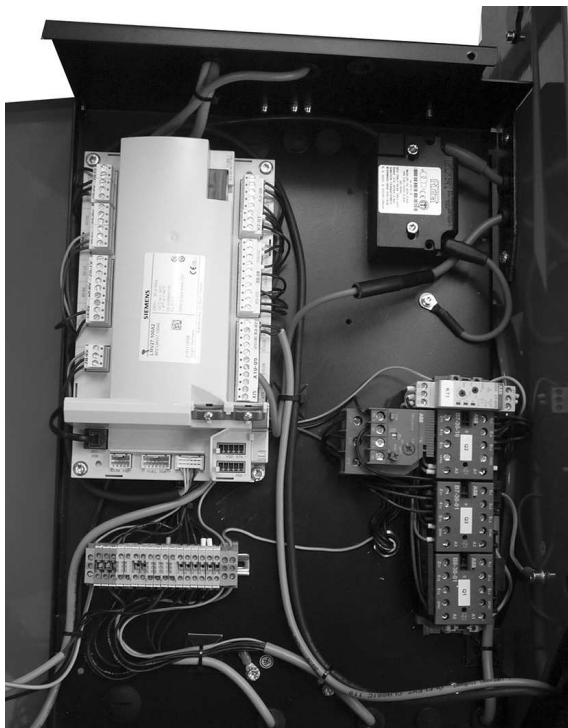

After wiring has been completed, check the direction of rotation of the burner motor.

The direction of rotation is correct when the fan wheel turns towards the boiler (also see arrow on the motor flange).

IMPORTANT !



The motor protection relay is set at the factory. The set value should not be modified.

13 Air flap positioning motor

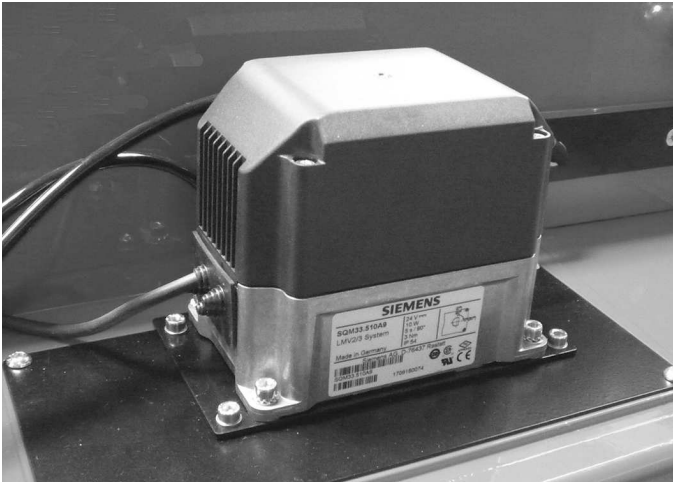

The air flap positioning motor is designed for air flap adjustment on progressive two-stage burners or modulating burners. The motor is activated electronically via the microprocessor-controlled control box.



Do not open the air flap actuator while it is under voltage. The internal optics would be destroyed. No warranty if the seal is broken!



14 Air pressure monitor

The air pressure switch is a differential pressure switch and monitors the air pressure at the forced-air burner.

The air pressure switch is pre-set at the factory.

15 Gas pressure monitor

15.1 Gas pressure switch min.

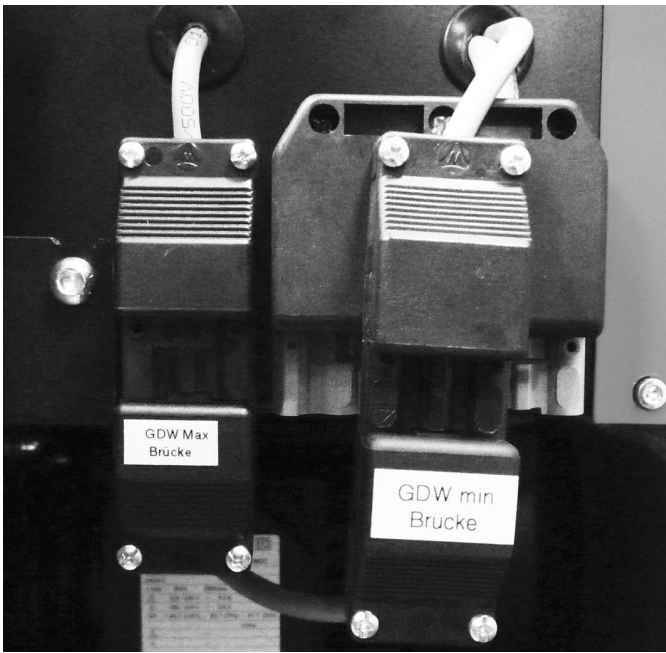

The **gas pressure switch MIN** at the gas fitting serves to monitor the gas inlet pressure. If the minimum gas inlet pressure is not reached (factory setting), the burner is switched off. The burner automatically starts again when the minimum pressure is exceeded. The gas pressure monitor as **density control DK** generally serves to check the valves and must be set to 50% of the static gas inlet pressure.

The monitoring of the gas inlet pressure and the tightness control are carried out either only with the gas pressure switch DK (**the plug bridge GDW MIN must not be removed**) or with the gas pressure switch MIN and the gas pressure switch DK (**in this case the plug bridge GDW MIN must be replaced with the connection of the gas pressure switch MIN**).



Additional parameterization of the LMV is not required here.

15.2 Gas pressure switch max.

Optionally, a gas pressure switch max. to be built in.

The LMV and the wiring are prepared so far that only the bridge in the socket (brown) on the burner has to be removed. In addition, the plug and the gas pressure switch must be max. Wired according to wiring diagram. If the gas pressure switch max. has triggered a fault in the display (AZL) displayed.

First, the gas pressure switch must be max. be unlocked, the lid of the gas pressure switch must max. unscrewed and the red button pressed.

Then the fault in the display (press the **i / reset** button for 3 sec.) Can be deleted.

16 Set the electrodes

The electrodes are preset at the factory

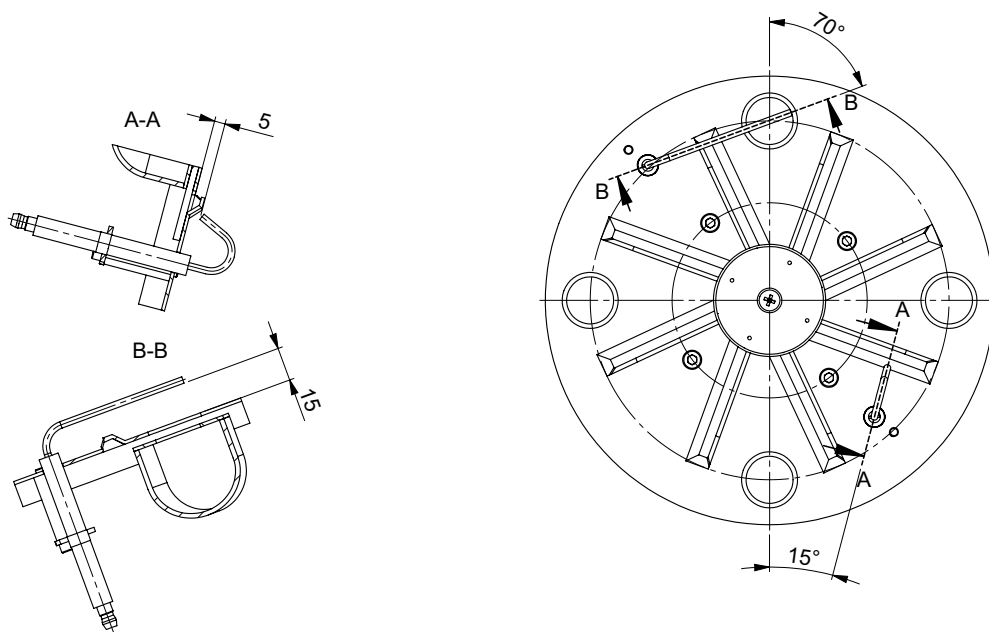

17 Adjusting the mixing head

The position of the mixing head is set depending on the output according to the tables on page 24:



18 Flame control with ionisation monitor

In the presence of an alternating-current voltage between burner and ionisation rod, the rectifying effect of the flame causes a direct current to flow. This ionisation current is the flame signal and is amplified before being output to the control box. A flame cannot be simulated, because the rectifying effect collapses if there is a short-circuit between sensor electrode and burner.

Measuring ionisation current

The ionisation current must be measured during burner start-up and maintenance or after a fault indication in the control box. Disconnect the plug of the ionisation cable and connect the ionisation measuring cable.

Perform measurement straight after the post-ignition time during the safety time period !



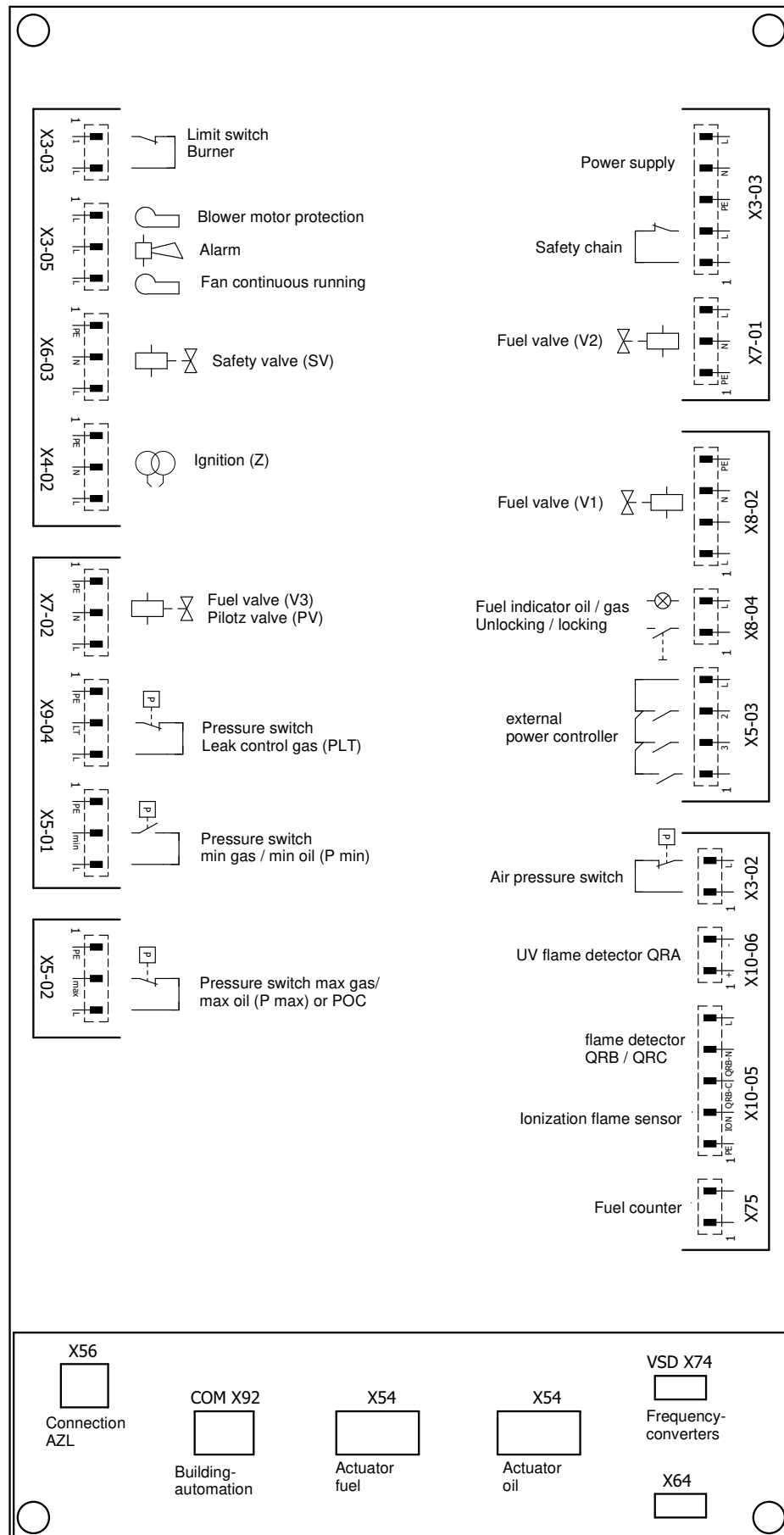

The ionisation current must be at least 1.5 μA . Currents lower than 1.5 μA cause unstable operation or shutdown. If the current is too low clean the ionisation rod and the inside of the burner tube. It may be necessary to correct the shape of the ionisation rod. If the ionisation rod is defective, replace the electrode. Reverse the polarity of the ignition transformer, if necessary. Check the cables for moisture formation and dry if necessary.

19 Connection diagram LMV27

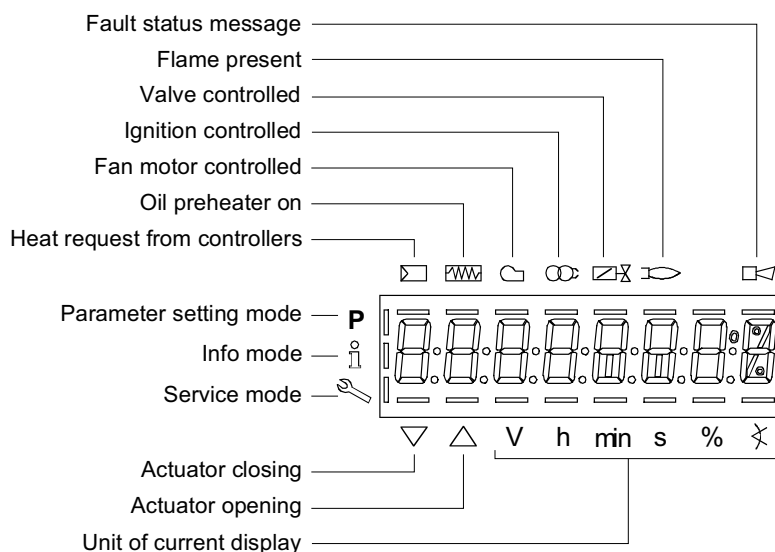

20 Operating instructions and equipment description LMV

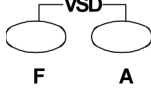
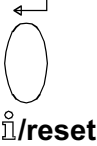

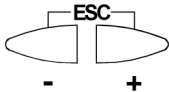
Button	Function
 F	F button - To adjust the fuel drive (Hold down the F button and set the value with the - or + button)
 A	A button - To adjust the air drive (Hold down the A button and set the value with the - or + button)
 F A	F and A button - To shift to parametrisation mode P (F and A button press simultaneously with - or + button) - To adjust the speed for frequency converter operation (FC) (F and A button press simultaneously with - or + button)
 i/reset	Information and enter button - To navigate in information and service mode * Selection (flashing symbol) increment (press button < 1 s) * To switch to a lower menu level (press button < 1 ... 3 s) * To switch to a lower menu level (press button < 3 ... 8 s) * To switch the operating mode (press button > 8 s) - Enter in parametrisation mode - Unlock in case of fault - One menu level down
 -	- Button - Reduce value - For navigating in curve setting, information and service mode
 +	+ Button - Increase value - For navigating in curve setting, information and service mode
 - +	- and + button: Escape function (Press - and + button simultaneously) - Do not accept the value - One menu level higher

21 Start-up and calibration

Determine the burner output according to the table on page 24. P0 = Start stage, P1 = 1st stage / min. output, P9 = 2nd stage / max. output.

Normally, P0 = P1. For the condensing boiler, P0 must be set higher than P1. The setting is dependent on the boiler. The mixer head must be set according to the table.



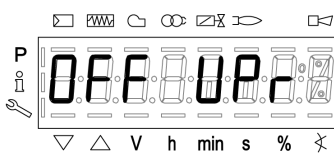
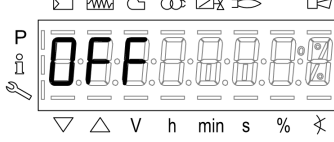

To enter this adjustment mode, the burner must be on standby.

Standby means that the burner is supplied with voltage, gas pressure is built up and there is no demand for heat.

The firing managers are parametrized in the factory. OFF UPr appears in the display during first start-up.

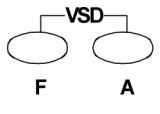
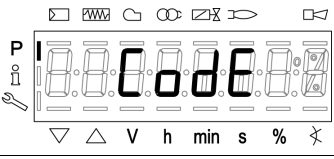
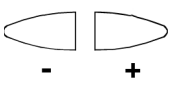
Action button	Display	Description
		OFF UPr means burner off and non-programmed.
		OFF means burner off and programmed.

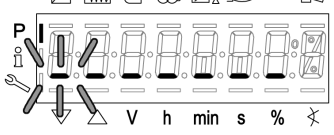

Enter password

Action button	Display	Description
		Press F and A button simultaneously. The display CodE appears
 		After releasing the buttons, 7 bars appear and the first one flashes. Use the - or + button to select a number or letter. Confirm each value with i/reset .
		Confirm the password 1234 with i/reset after the last input.
		After correct input, the following appears for a max. of two seconds

Switch on the burner



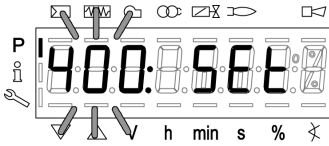

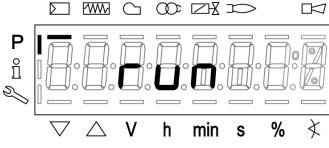
Continuous heat requirement is necessary for further start-up!

LMV programmed

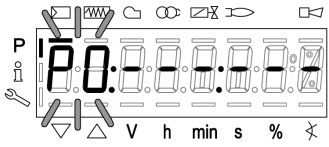

Action button	Display	Description
 i/reset		
 i/reset		<p>When the firing machine is programmed, run is displayed.</p> <p>i/reset skips the next steps and continues at the section Start heat settings with curve point P1 Small load.</p>

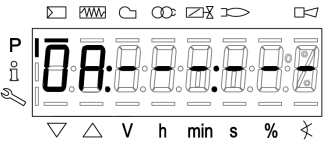
Start load preset

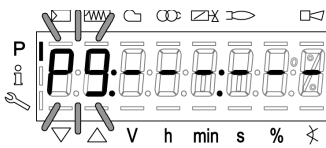
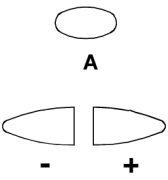
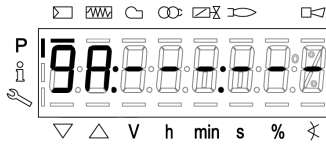

Use the values from the setting tables to preset the values.

Action button	Display	Description
		Set the start position air flap.
 A  - +		Hold down button A and set the value with the - or + button .
 +		Move to the next curve point.

High load preset



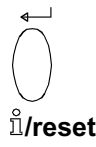
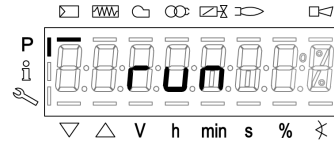
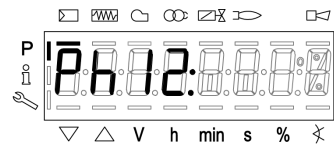

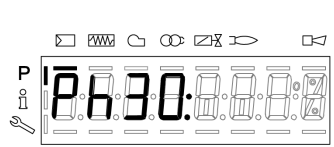

Action button	Display	Description
		Set the high load air flap.
		Hold down button A and set the value with the - or + button .
		Move to the next curve point.

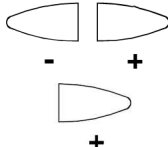
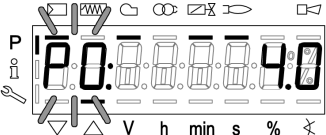

Start identifier for curve programming - Calibration with flame

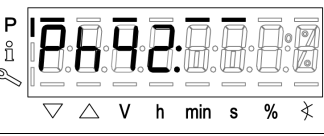
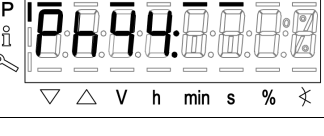
Action button	Display	Description
		When heat demand is present. Confirm with i/reset button .
		Burner start with pre-ventilation.
		Blower start-up and safety valve ON
		Run in pre-ventilation position
		Pre-ventilation
If the leakage check is activated, Ph80, Ph81, Ph82 and Ph83 are displayed first.		

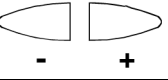
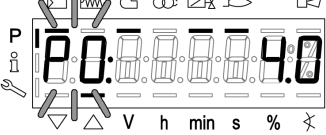



Action button	Display	Description
		Driving in ignition position

Start heat setting

Action button	Display	Description
 		The ignition position P0 cannot be set until the symbols ▼▲ disappear. Hold down A button a set the value with the - or + button . Press + button to confirm.
		Ignition ON
		Valves ON
		Ignition OFF
		Flame in start position
 		When transferring P1 to P2 for the first time, CALC appears briefly The curve points P2 to P9 are calculated automatically as a straight line.
		Use + button to confirm all curve points up to curve point P9. In curve point P9 , set the excess air for the high load at the gas train using the adjusting screw "V" or "large flame" . The CO ₂ value should be 9-10% for natural gas.

Action button	Display	Description
		Use the - button to select curve point P1 . In curve point P1 , set the excess air for the high load at the gas train using the adjusting screw " N " or " small flame ". The CO ₂ value should be 9-10% for natural gas.
		Use the + button to select curve point P9 again. In curve point P9 , check the excess air for the high load at the gas train and correct using the adjusting screw " V " or " large flame ".

Setting the output in high and low-load operation

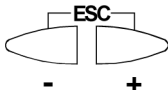
Action button	Display	Description
 		Check the high-load setting via the gas flow at the gas meter or compare the nozzle pressure with the values stated in 24. Adjustment tables. Hold down A button and use the - or + button to set the output for curve point P9 . The air surplus is not affected by this adjustment.
		Use the - button to select curve point P1. Check the small-load setting via the gas flow at the gas meter or compare the nozzle pressure with the values stated in 24. Adjustment tables.
		Back to curve point P9
		After setting all curve points, the burner is ready for operation. Press the ESC button briefly 3x to save all curve points and access automatic mode.

LMV phase display

Display	Description
Ph00	Fault phase
Ph01	Safety phase
Ph10	Go home
Ph12	Standby (stationary)
Ph22	Blower start-up time (blower motor = ON, safety valve = ON)
Ph24	Run in pre-air position
Ph30	Pre-air time
Ph36	Run in ignition position
Ph38	Pre-ignition phase
Ph39	Leakage check filling time (test pressure switch min for installation between fuel valve 1 and fuel valve 2)
Ph40	First safety time (ignition transformer ON)
Ph42	First safety time (ignition transformer OFF)
Ph44	Interval 1
Ph50	Second safety time
Ph52	Interval 2
Ph60	Operation 1 (stationary)
Ph62	Maximum time small-load setting (operation 2, preparation decommissioning, run in small-load setting)
Ph70	After-burn time
Ph72	Run in post-ventilation position
PH74	Post-ventilation time (no external leak test)
Ph78	Post-ventilation time (abort when power controller ON)
Ph80	Leakage check idle time
Ph81	Leakage check test time atmospheric pressure, atmosphere test
Ph82	Leakage check filling test, filling
Ph83	Leakage check test time gas pressure, pressure test
Ph90	Gas shortage waiting time

22 Gas burner with gas train

Installation of the gas train	
Installation position	only in horizontal line, not tilted.
Minimum distance to masonry	20 mm

The nipple for the compressed air connection P_L must be screwed in at the top of the gas jacket (see 9. Mounting the gas jacket at the boiler).

Connect the blue hose at the "AIR" connection of the gas train and at the air pressure connection at the gas jacket. The blue hose serves as a control line for the gas train and must be routed in a loose loop without kinking.

Burner start:

If the burner does not go into operation, turn adjusting screw **N** or small flame slightly in the direction "+" and repeat start.

KEV 1 1/2", KEV2", KEV DN65 (VGD20.40, VGD20.50, VGD40.65 alle SKP15/75) .

Cover plate for
Adjustment screws

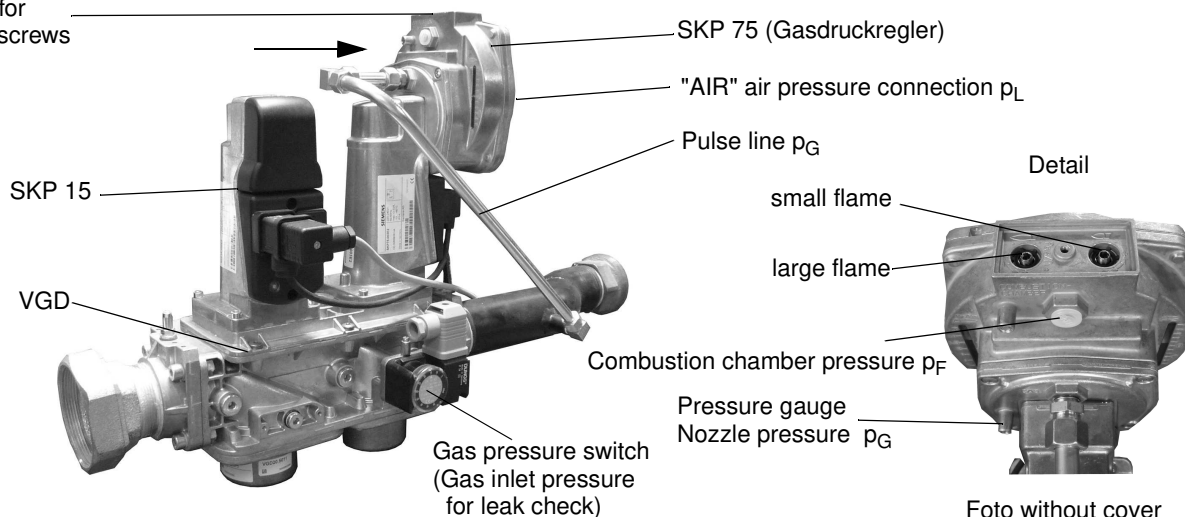

Large flame / "V" setting	Exhaust gas analysis values	
Change in "+" direction if:	CO ₂ too low	O ₂ too high
Change in "-" direction if:	CO ₂ too high	O ₂ too low

Small flame / "N" setting	Exhaust gas analysis values	
Change in "+" direction if:	CO ₂ too low	O ₂ too high
Change in "-" direction if:	CO ₂ too high	O ₂ too low



Caution !
Difference between baffle plate pressure p_L - furnace pressure p_F must be at least 0.3 mbar.

23 Calculation principles for gas burner adjustment

The values given in the tables are setting values for start-up.

The necessary system adjustment must be newly determined in each case.

General:

The calorific value ($H_{i,n}$) of fuel gases is generally specified for the normal state (0°C, 1013 mbar).

Natural gas type E	$H_{i,n} = 10.4 \text{ kWh/m}^3$
Natural gas type LL	$H_{i,n} = 9.3 \text{ kWh/m}^3$

Gas counters measure the volume of gas in the operational state.

Gas flow determination:

To allow the heat generator load to be adjusted correctly, the gas flow rate must be determined in advance.

Example:

Height above sea level	230 m
Atmospheric pressure B (acc. to Tab.)	989 mbar
Gas pressure P_G at gas meter	20 mbar
Gas temperature ϑ_G	16°C
Boiler output Q_n	220 kW
Efficiency η_K (assumed)	92%
Calorific value $H_{i,n}$	10.4 kWh/m ³

Gas flow in standard state (V_n)

$$V_n = \frac{Q_n}{\eta_K \times H_{i,n}} = \frac{220 \text{ kW}}{0,92 \times 10,4 \frac{\text{kWh}}{\text{m}^3}} = 23 \frac{\text{m}^3}{\text{h}}$$

Gas flow in operating state (V_B)

$$V_B = \frac{V_n}{f} = \frac{23 \frac{\text{m}^3}{\text{h}}}{0,94} = 24 \frac{\text{m}^3}{\text{h}}$$

Conversion factor (f)

$$f = \frac{B + P_G}{1013} \times \frac{273}{273 + \vartheta_G}$$

Annual average air pressure

Average geodetic altitude of the supply region above sea level [m]	from to	0	1 50	51 100	101 150	151 200	201 250	251 300	301 350	351 400	401 450	451 500	501 550	551 600	601 650	651 700	701 750
Annual average of air pressure	(mbar)	1016	1013	1007	1001	995	989	983	977	971	965	959	953	947	942	936	930

Legend:

Q_n =	boiler output [kW]
η_K =	efficiency [%]
$H_{i,n}$ =	lower standard calorific value [kWh/m ³]
f =	conversion factor
B =	atmospheric pressure [mbar]
p_G =	gas pressure at gas meter [mbar]
ϑ_G =	gas temperature at gas meter [°C]

24 Adjustment tables

							Natural gas LL: $H_{i,n} = 9,3 \text{ [kWh/m}^3\text{]}$				
Burner output MGN2300-LN		Boiler output $\eta_k = 92\%$		Position air flap		Position Mixing head	Gas nozzle pressure		Gas throughput		
2.Stage	1. Stage	2.Stage	1. Stage	2.Stage P9	1. Stage P1		2.Stage	1. Stage	2.Stage	1. Stage	
[kW]	[kW]	[kW]	[kW]	[°]	[°]	[mm]	[mbar]	[mbar]	[m ³ /h]	[m ³ /h]	
900	450	828	414	16	5,5	20	11,5	3,5	101,3	50,7	
1100	550	1012	506	23	7,5	20	17	4,5	123,9	61,9	
1300	650	1196	598	42	10	20	25,3	6,4	146,4	73,2	
1400	750	1288	690	48	12,5	20	28	8	157,6	84,4	
1600	850	1472	782	55	15	0	33,5	9,7	180,1	95,7	
1800	950	1656	874	63	17,5	0	39	13,2	202,7	107,0	
2100	1050	1932	966	72	20	0	44,5	16,4	236,4	118,2	
2200	1150	2024	1058	80	23	0	50	19,7	247,7	129,5	
2300	1250	2116	1150	90	25,5	0	55,5	23	259,0	140,7	

							Natural gas E: $H_{i,n} = 10,4 \text{ [kWh/m}^3\text{]}$				
Burner output MGN2300-LN		Boiler output $\eta_k = 92\%$		Position air flap		Position Mixing head	Gas nozzle pressure		Gas throughput		
2.Stage	1. Stage	2.Stage	1. Stage	2.Stage P9	1. Stage P1		2.Stage	1. Stage	2.Stage	1. Stage	
[kW]	[kW]	[kW]	[kW]	[°]	[°]	[mm]	[mbar]	[mbar]	[m ³ /h]	[m ³ /h]	
900	450	828	414	16	5,5	20	9,0	2,7	90,6	45,3	
1100	550	1012	506	23	7,5	20	13,3	3,5	110,8	55,4	
1300	650	1196	598	42	10	20	19,8	5,0	130,9	65,4	
1400	750	1288	690	48	12,5	20	21,9	6,3	141,0	75,4	
1600	850	1472	782	55	15	0	26,2	7,6	161,1	85,6	
1800	950	1656	874	63	17,5	0	30,5	10,3	181,2	95,7	
2100	1050	1932	966	72	20	0	24,8	12,8	211,4	105,7	
2200	1150	2024	1058	80	23	0	39,1	15,4	221,5	115,8	
2300	1250	2116	1150	90	25,5	0	43,4	18,0	231,6	125,9	

25 Error code list LMV

loc.C:	loc.d:	Description	Measure
		No communication between basic unit LMV27... and AZL2...	Check wiring for interruptions/loose contacts
2	1 - 4	No flame at the end of the safety time	
3	0 - 84	Compressed air fault	No compressed air
4	0 - 86	External light	
7	0 - 255	flame cut-off	
12	0	Fuel valve 1 leaking (fuel valve 2 for leakage check 9	For leakage check via X5-01 (gas pressure switch min) - Check whether valve on burner side is leaking - Check whether pressure switch for leakage check is closed when gas pressure is applied - Check wiring for short-circuit
	1	Fuel valve 2 leaking (fuel valve 1 for leakage check via X5-01)	For leakage check via X5-01 (gas pressure switch min) - Check whether valve on gas side is leaking - Check wiring for short-circuit
	2- 5	Leakage check not possible	Leakage check activated but no input assigned
	81	V1 leaking	Check whether valve on gas side is leaking Check the wiring for interruptions
	83	V2 leaking	Check whether the valve on the burner side is leaking Check whether the pressure switch for the leak test is closed when gas pressure is applied Check wiring for short-circuit
14	0	POC open	Check whether valve NC contact is closed
	1	POC closed	Check wiring Check whether valve NC contact opens when the valve is activated
	64	POC open start prevention	Check wiring for interruptions Check whether valve NC contact is closed
19	80	Combustion pressure, POC start prevention	Check whether the pressure switch is closed without combustion pressure being present Check wiring for short-circuit
20	0 - 1	Pressure switch min no minimum gas pressure/oil pressure	Check wiring for interruption
21	0- 64	Pressure switch max/POC	Check wiring for interruption. POC: Check whether valve NC contact is closed
22 OFF S	0 - 87	Safety chain	
23	0 - 2	Gas pressure switch min (Pmin)	Check wiring for interruption (X5-01)
50 - 67	#	Internal error	
70	26 - 26	Error group	Set all curve points for gas and air actuators, and for the FC
71	0 - 3	Special position undefined	Parametrise actuators
75-84		Internal fault group	
85	0	Error group fuel drive	Referencing of fuel drive not possible. Unable to reach reference point. 1. Check whether the drives have been exchanged 2. Check whether the drive is blocked or overloaded

loc.C:	loc.d:	Description	Measure
85	1	Error group air drive	Referencing of fuel drive not successful. Unable to reach reference point. 1. Check whether the drives have been exchanged 2. Check whether the drive is blocked or overloaded
86	0 - 1	Error group fuel drive	Unable to achieve the target position within the required tolerance. -> Check whether the drive is blocked or overloaded. A line break was detected at the drive connections. -> Check wiring (voltage X54 between Pin 5 or 6 and Pin 2 >0.5 V).
87	0 - 4	Error air drive	Unable to achieve the target position within the required tolerance. -> Check whether the drive is blocked or overloaded. A line break was detected at the drive connections. -> Check wiring (voltage X53 between Pin 5 or 6 and Pin 2 >0.5 V).
90 - 92	#	Internal fault group	
93	3	Short-circuit of probe	Short-circuit at QRB... 1. Check wiring 2. Flame probe possible defective
95	3 Ignition transformer 4 Fuel valve 1 5 Fuel valve 2 6 Fuel valve 3	External supply NOC	Check wiring
96	3 Ignition transformer 4 Fuel valve 1 5 Fuel valve 2 6 Fuel valve 3	Relay welded	Measure the contacts: 1. Device at voltage: Blower output must be de-energised 2. Deactivated voltage: Disconnect blower. There must be no ohmic connection between blower output and N. If one of the two tests fails, replace the unit, since the contacts are definitely welded and safety can no longer be guaranteed.
97	0	Safety relay welded or external voltage at safety contact	Measure the contacts: 1. Device at voltage: Blower output must be de-energised 2. Deactivated voltage: Disconnect blower. There must be no ohmic connection between blower output and N. If one of the two tests fails, replace the unit, since the contacts are definitely welded and safety can no longer be guaranteed.
98	2 Safety valve 3 Ignition transformer 4 Fuel valve 1 5 Fuel valve 2 6 Fuel valve 3	Replay does not pick up	Unlock; if it recurs, replace the unit
99 - 250	#	Internal error	

26 Adjustments log

Please enter the measured values into the Adjustments log.

Boiler type	Gas fitting

Measured values		min.	max.	Date
P0 (start point)				
P1 (min load)				
P9 (max load)				
Flue gas temperature	°C			
Carbon dioxide (CO ₂ level)	%			
O ₂ content	%			
CO level	%			
Flue	mbar			
Nozzle pressure	mbar			
Boiler pressure	mbar			
Room temperature	°C			
Gas type				
Setting value V at the fitting				
Setting value N at the fitting				

27 Exploded view drawing / spare parts list

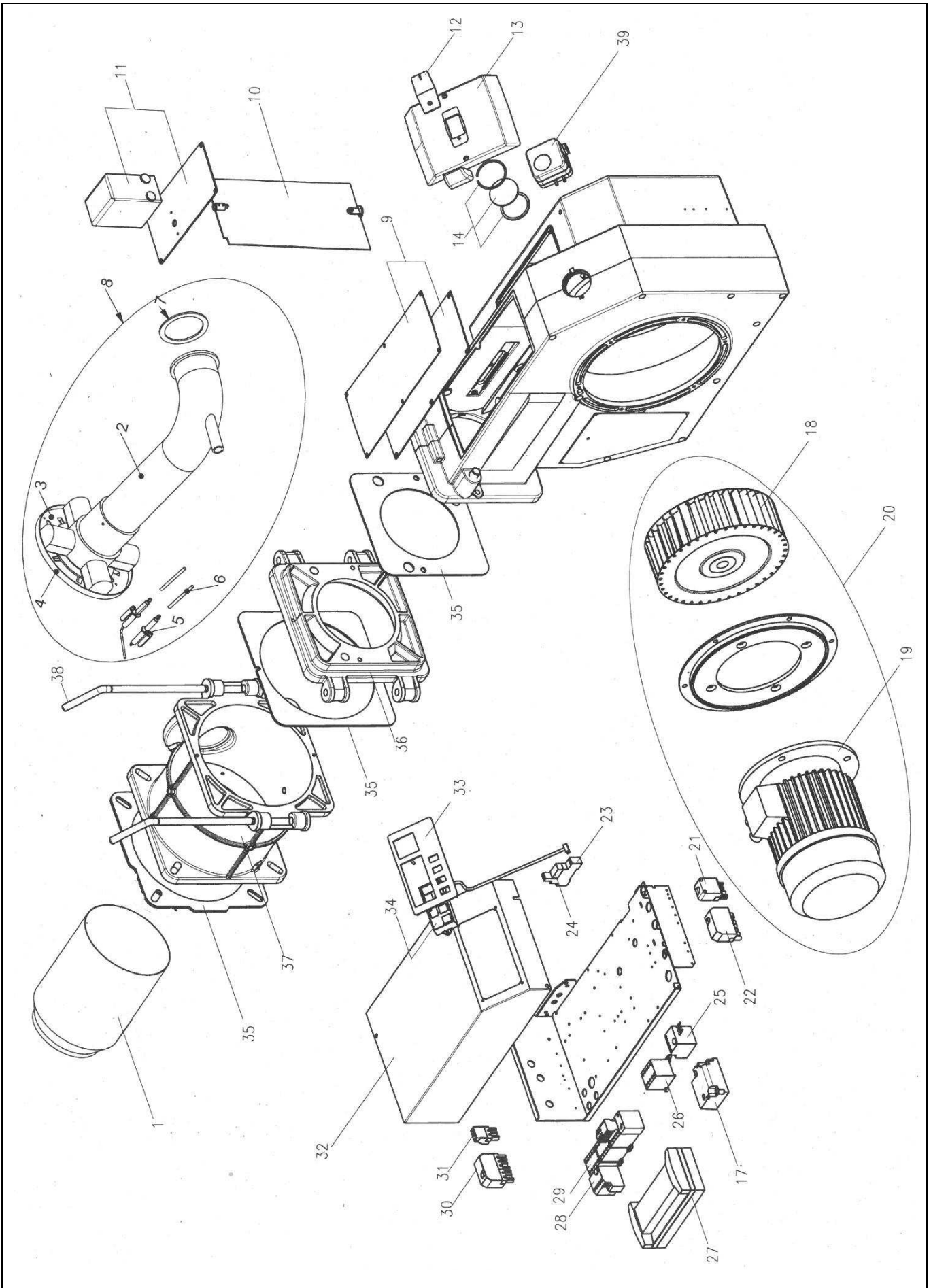

Item	Designation	PU	Art. No.
1	Burner tube MGN2300-LN Modell 2021		47-90-30150
2	Gas nozzle tube MGN2300-LN Modell 2021		47-90-30159
3	Flow plate Ø 200, MGN2300-LN Modell 2021		46-90-30146
4	Gas nozzle primary MGN2300-LN Modell 2021		47-90-30147
5	Ignition and ionization electrode-set Modell 2021		47-90-30172
6	Spare parts set ignition and ionization cables		47-90-30174
7	Seal for gas nozzle	5	47-50-12791
8	Gas nozzle MGN2300-LN Modell 2021, cpl.		46-90-30124
9	Cover with seal		47-90-12982
10	Air damper MGN2300-LN		47-90-29331
11	SQM 33 actuator, pre-assembled		47-90-29332
12	Cover for sight glas	5	47-50-12106
13	Hood		47-90-24999
14	Inspection glass with seal		36-90-11544
17	Ignition transformer Mod. 26/35		47-90-26790
18	Fan wheel TS Ø 280 x 114		47-90-22581
19	Motor 4,5 kW / E3		47-90-29350
20	Motor 4,5 kW with fan wheel		47-90-26800
21	4-pole female connector green		37-90-20744
22	7-pole female connector black/brown		37-90-20731
23	Socket CR-PLSx		47-90-26713
24	Relay CR-P230AC2		47-90-25199
25	Thermal over-current relay 9,0 - 12,0 A		47-90-25175
26	Motor contactor B7-30-10		47-90-25171
27	Burner management system LMV27		47-90-29079-02
28	Thermal over-current relay 4,2 - 5,7 A		47-90-25173
29	Star-delta starter YKB-30		47-90-25176
30	7-pole female, green		37-90-10831
31	3-pole female concector black		37-90-20739
32	Electronic unit hood		47-90-25206
33	Panel		47-90-29089
34	Display and operating unit AZL		47-90-29098
35	Gasket set		47-90-26792
36	Gas jacket part 2		47-90-12771
37	Gas jacket part 1		47-90-12770
38	Securing rod	2	46-90-12809
39	Differential pressure switch LGW 50 A2		44-90-20793
-	Fan inlet device		47-90-12785
-	Protective screen		46-90-12992
-	Bridges male connector 3-pol. brown gas max		47-90-27382
-	Bridges male connector 3-pol. black gas min		47-90-27399
-	Female part 3-pol. brown		47-90-27203
-	Female part 3-pol. black		37-90-20739

28 Dimensions

(all dimensions are given in mm)

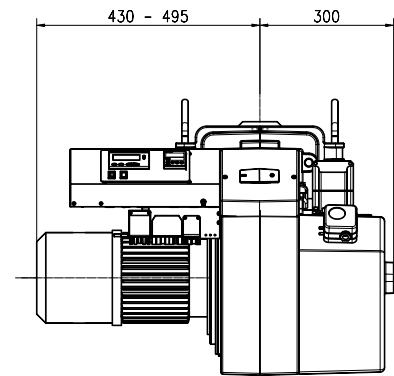
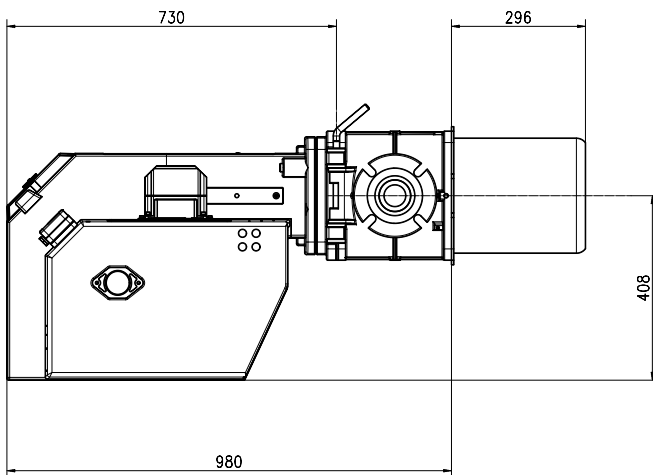

29 Working range

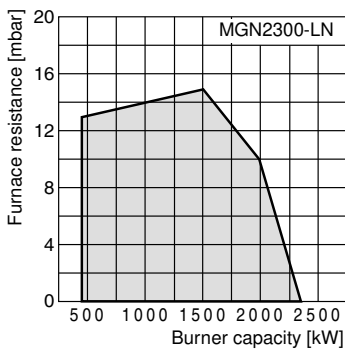

Working range acc. to DIN EN 676. The working range is referred to 15°C and 1013 mbar.

All information in this technical documentation as well as the drawings, photos and technical descriptions placed at your disposal remain our property and may not be duplicated without our written permission given in advance.
Rights reserved to effect modifications.

NU-WAY

Nu-way Limited, P O Box 1, Vines Lane, Droitwich,
Worcestershire, England, WR9 8NA

Tel: 01905 / 79 43 31 • Fax: 01905 / 79 40 17

email: info@nu-way.co.uk • www.nu-way.co.uk